

Vector Frame Monitor Kiosk 01

VF-MK-01-SS

Vector Frame™ monitor kiosks are a sleek, stylish way to display media at any trade show, event, in a retail or corporate space. These new kiosks feature push-fit fabric graphics, easy-to-assemble 100mm extrusion frames and your choice of one or two monitor mounts (monitors not included). These kiosks compliment the Vector Frame line of banners, back-wall, exhibit kits and counters.



front with graphic & monitor mount

back graphic options

back with opaque liner

back with graphic

back with graphic & monitor mount

top view one monitor mount

top view two monitor mounts

features and benefits

- 100mm silver extrusion frame
- Single or double-sided SEG dye-sublimated fabric graphics
- Kiosk supports 32-55" monitor*; max weight = 80 lbs each
- PM4S2 extrusion max height 59"
- Comes packaged in one OCH wheeled molded case for transport or storage
- Lifetime hardware warranty against manufacturer defects

dimensions

Hardware	Graphic
<p>Assembled unit: 36.3"w x 94.74"h x 25.59"d 922mm(w) x 2406mm(h) x 650mm(d)</p>	<p>Refer to related graphic templates for more information</p> <p>Visit: www.exhibitors-handbook.com/graphic-templates/</p>
<p>Shipping</p> <p>Shipping dimensions: 1 OCH case: 50"l x 26"h x 12"d 1270mm(l) x 660mm(h) x 305mm(d)</p> <p>Approximate shipping weight (with case): 83 lbs / 38 kgs</p>	

additional information

Graphic material:
Dye-sublimated fabric

*monitor(s) not included

We are continually improving and modifying our product range and reserve the right to vary the specifications without prior notice. All dimensions and weights quoted are approximate and we accept no responsibility for variance. E&OE. See Graphic Templates for graphic bleed specifications.

Included In Your Kit

Tools, Components, & Connectors



5MM ALLEN-T x1

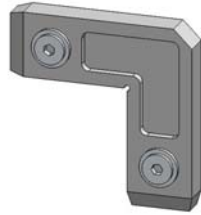

CB9 x4

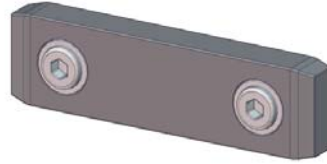

IB2 x2



SW-FOOT-650-LN x2



EXT-M-MB x1

Graphics



VF-MK-01-CC-G x1



VF-MK-01-NC-G x1

Extrusions

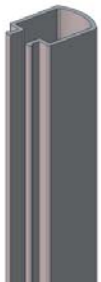

WME-300 x1
WME-1000 x1



PHFC4-900-MCB9-MCB9 x2



PHFC4-1200-L1-MCB9 x3



PHFC4-1200-L1-MCB9-GR x1



PM4S2-810-L-L x1

Exploded View

VF-MK-01-SS

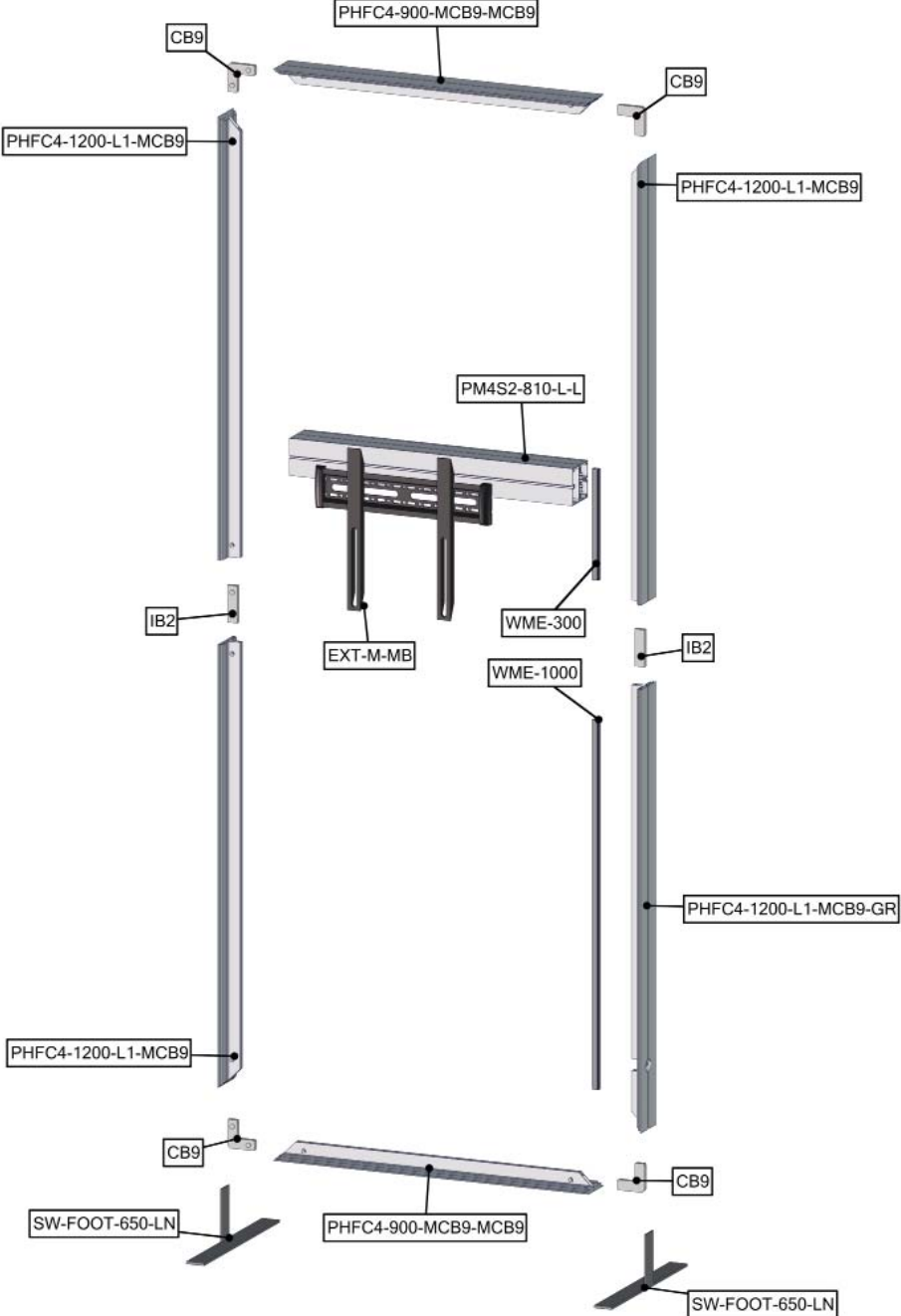

Connection Methods

Extrusion based structures use a number of different yet simple connection methods. Your kit will include one or more of the connection methods shown below. Steps within the Kit Assembly will reference a specific method for each connection point.

Connection Method 1: Cam Lock / Slide Lock

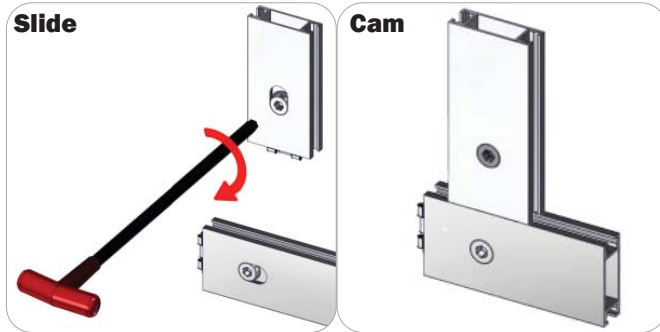

A cam lock equipped extrusion can lock to any cam lock channel. With the cam lock unlocked, set the teeth of the cam lock into the desired position on the cam lock channel. Using your allen key tool, carefully turn the lock clockwise to lock in place. Be sure to lock securely, but do not over tighten.

A slide lock equipped extrusion can also lock into any cam lock channel. When the slide lock is unlocked, pull back on the hex bolt head to retract the slide lock into the body of the extrusion. Slide locking procedure is the same as a cam lock.

Connection Method 2: IB2 / Corner Brackets

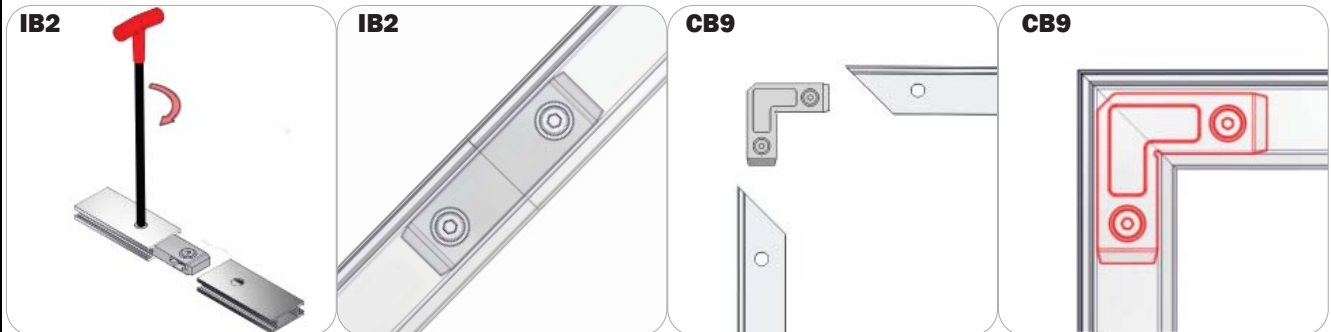

Press the hex bolt head in with your thumb and slide the extrusion and connector together so that the hex bolt head sits into the lock hole. Repeat with the second extrusion to the free end of the connector. Lock the extrusions together by turning carefully with the allen key tool. Be sure to lock securely, but do not over tighten.

Connection Method 3: SW-FOOT



An SW-FOOT assembly consists of two thumb screws, an LN100, and SW-FOOT baseplate. Start by loosening the thumb screws (it is best not to completely remove the screws). Slide the extrusion onto the LN100 by utilizing its back cam channel. When the extrusion rests on baseplate or ground (depending on application), tighten the thumb screws to lock in place. Do not over tighten.

Connection Method 4: Internal Lighting Setup

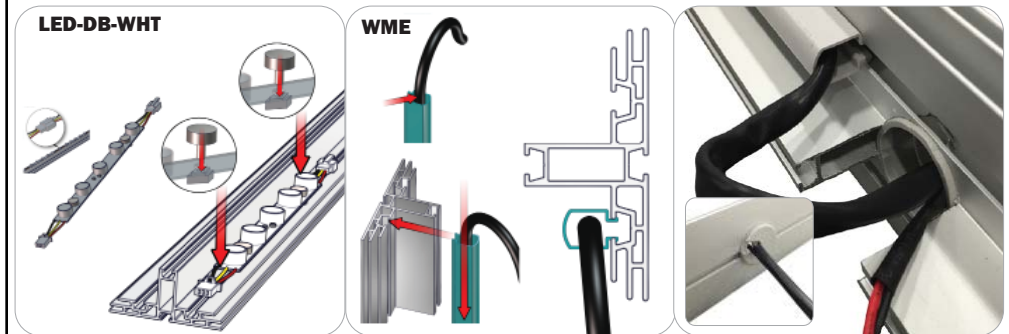

Be sure to fully assemble all frames before using the internal lighting components. With the thumbscrews loosened, place the light strips on the frame, then hand tighten them in series, male to female connections with extension cords. Do not over tighten the thumbscrews. Snap on the wire management extrusions with the power cord extensions in place. Reference the Internal Lighting Diagram for more details.

Kit Assembly

Step by Step

Step 1.

Gather the components necessary for assembling your frame. Assemble in the order the Exploded View instructs.

Refer to Connection Methods 1 and 2 for additional information.



Step 2.

Slide in the two square bolts that are provided with the monitor mount bracket into the PM4S2 extrusion front channel. Locate your silicone edge fabric panels. Push the silicone edges of the graphic panel into the primary grooves of the PHFC4 extrusion perimeter. The square bolts will protrude through the graphic.



Step 3.

Gather the components necessary for finishing your frame accessory. Assemble in the order the Exploded View instructs.

Refer to Connection Method 3 and the Monitor Bracket Instructions for additional information.



Step 4.

Setup Complete.



Monitor Bracket Instructions

Extrusion Channel Applications



EXT-SM-MB

Sizes: 17" - 37"

Max weight varies per application

Assembled unit:

9" w x 16" h x 1.4" d
230mm (w) x 410mm (h) x 35mm (d)

Shipping dimensions:

14" l x 6" h x 4" d
356mm (l) x 152mm (h) x 102mm (d)

Approximate total shipping weight:

6 lbs / 2.7 kgs

VESA:

75 x 75 - 200 x 200mm



EXT-M-MB

Sizes: 32" - 55"

Max weight varies per application

Assembled unit:

16" w x 16" h x 1.4" d
410mm (w) x 410mm (h) x 35mm (d)

Shipping dimensions:

24" l x 4" h x 4" d
610mm (l) x 102mm (h) x 102mm (d)

Approximate total shipping weight:

7 lbs / 3.2 kgs

VESA:

100 x 100 - 400 x 400mm



EXT-LG-MB

Sizes: 40" - 65"

Max weight varies per application

Assembled unit:

24" w x 16" h x 1.4" d
610mm (w) x 410mm (h) x 35mm (d)

Shipping dimensions:

28" l x 6" h x 6" d
711mm (l) x 152mm (h) x 152mm (d)

Approximate total shipping weight:

8 lbs. / 3.6 kgs

VESA:

100 x 100 - 600 x 400mm

Included hardware:

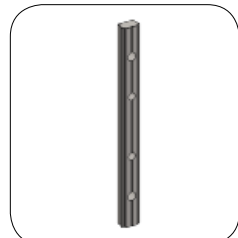

LN-100

x2



LN-LCD-SCW

x2



Square Bolt

x2



Wingnut

x2

EXTRUSION CONNECTION

Channel Connection A

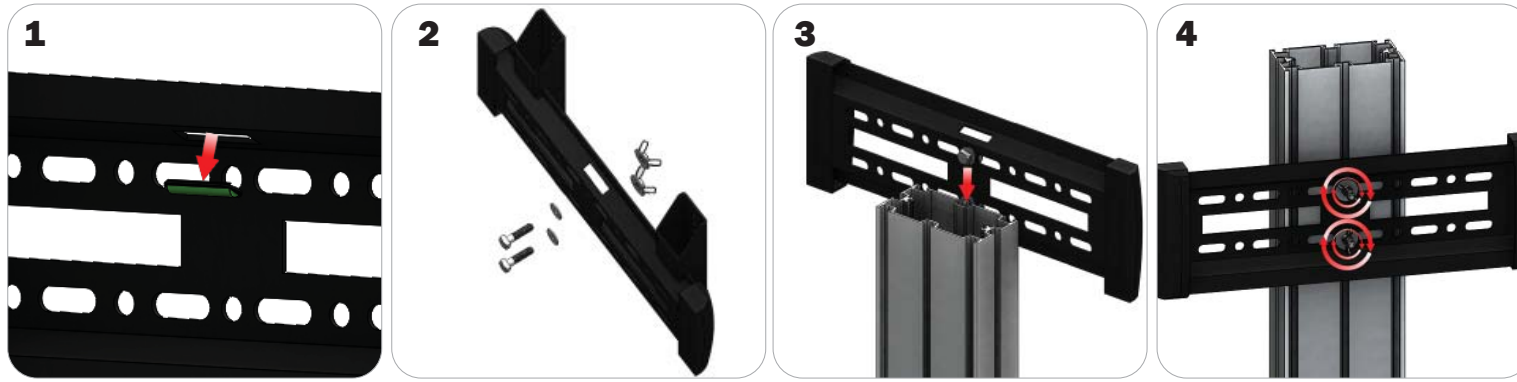

Locate all components needed to assemble the monitor mount with the channel connection A method. You will need (1) monitor bracket, (2) square head bolts, (2) washers, and (2) wingnuts.

Step 1: Apply pressure to the rear side of the leveling gauge clipped into the monitor mount to remove it. **Step 2:** Insert the provided bolts through the washers and center top and bottom holes of the monitor mount. Loosely thread your wingnuts onto the end of the bolts. **Step 3:** Slide the bolt heads down the extrusion channel.

Step 4: Tighten your wingnuts to lock the monitor bracket in place. **Step 5:** Reference the included manufacturer monitor mount instructions for fastening your monitor to the bracket.

Channel Connection B

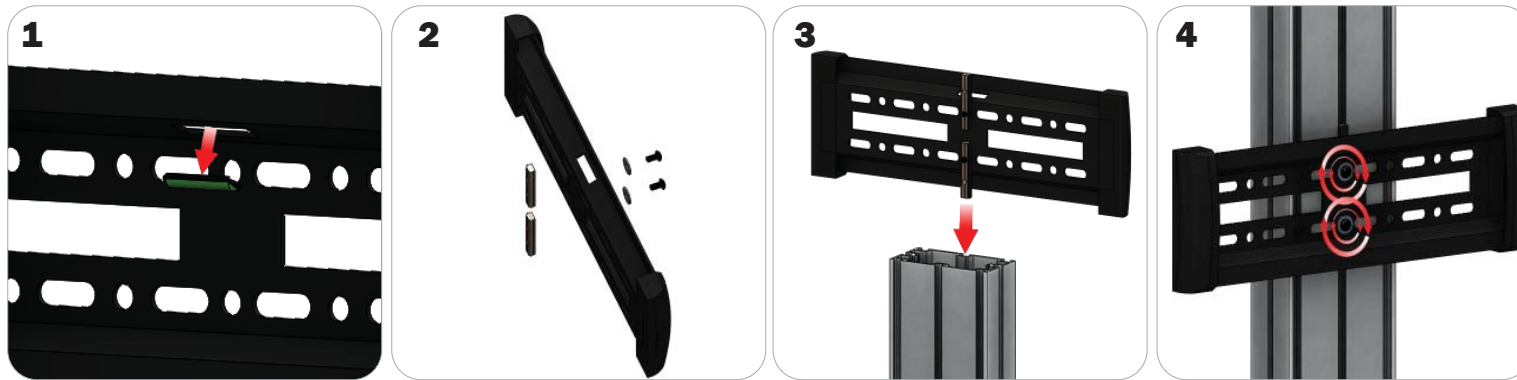

Locate all components needed to assemble the monitor mount with the channel connection B method. You will need (1) monitor bracket, (2) LN-LCD-SCW, (2) LN-100, and (2) washers.

Step 1: Apply pressure to the rear side of the leveling gauge clipped into the monitor mount to remove it. **Step 2:** Loosely thread the LN-LCD-SCW screws through the washers, the center top and bottom holes of the monitor bracket, and through the LN-50 holes. **Step 3:** Slide the LN-100s down the extrusion channel. **Step 4:** Tighten your LN-LCD-SCW to lock the monitor bracket in place.

Step 5: Reference the included manufacturer monitor mount instructions for fastening your monitor to the bracket.

TRI-30MM Channel Tube Connection



Locate all components needed to assemble the monitor mount with the TRI-30MM Channel Tube Connection method. You will need (1) monitor bracket, (2) Square Bolts, and (2) Wingnuts.

Step 1: Slip the head of the square bolts into the extrusion channel of the tube. **Step 2:** Apply your monitor bracket to the protruding square bolts. **Step 3:** Lock your monitor bracket to the square bolts using the provided wingnuts. **Step 4:** Reference the included manufacturer monitor mount instructions for fastening your monitor to the bracket.