



PRINTING & MAILING SPECIALISTS SINCE 1934

// **VOLUME 8**
WAYFINDING
SIGN SYSTEMS

17"
frame dimension

18.19"

17-15/16"

graphic dimension

2019 ISSUE 1

TABLE OF CONTENTS

■ FLAT WAYFINDING

WALL SIGNS	3
DIRECTORIES	8
PROJECTING SIGNS	10
SUSPENDED SIGNS	12
TRIANGULAR SIGNS	13
DESK FRAMES	13

■ CURVED WAYFINDING

WALL SIGNS	15
DIRECTORIES	18
PROJECTING SIGNS	22
SUSPENDED SIGNS	24
TRIANGULAR SIGNS	26
DESK FRAMES	27

■ SNAPPING SOLUTIONS

POSTER FRAMES	30
PROJECTING	32
SUSPENDED	33

■ STANDING SIGN SOLUTIONS

PYLONS & INFO CENTERS	35
-----------------------	----



Introducing: FLAT SYSTEM

- //Modern Flat Shape
- //Round or Square Profile
- //Black or Silver
- //Customized Options



CURVED SYSTEM

- //Sleek Curved Shape
- //Black or Silver or combination thereof
- //Customized Options

INTRODUCTION



FLAT SYSTEM

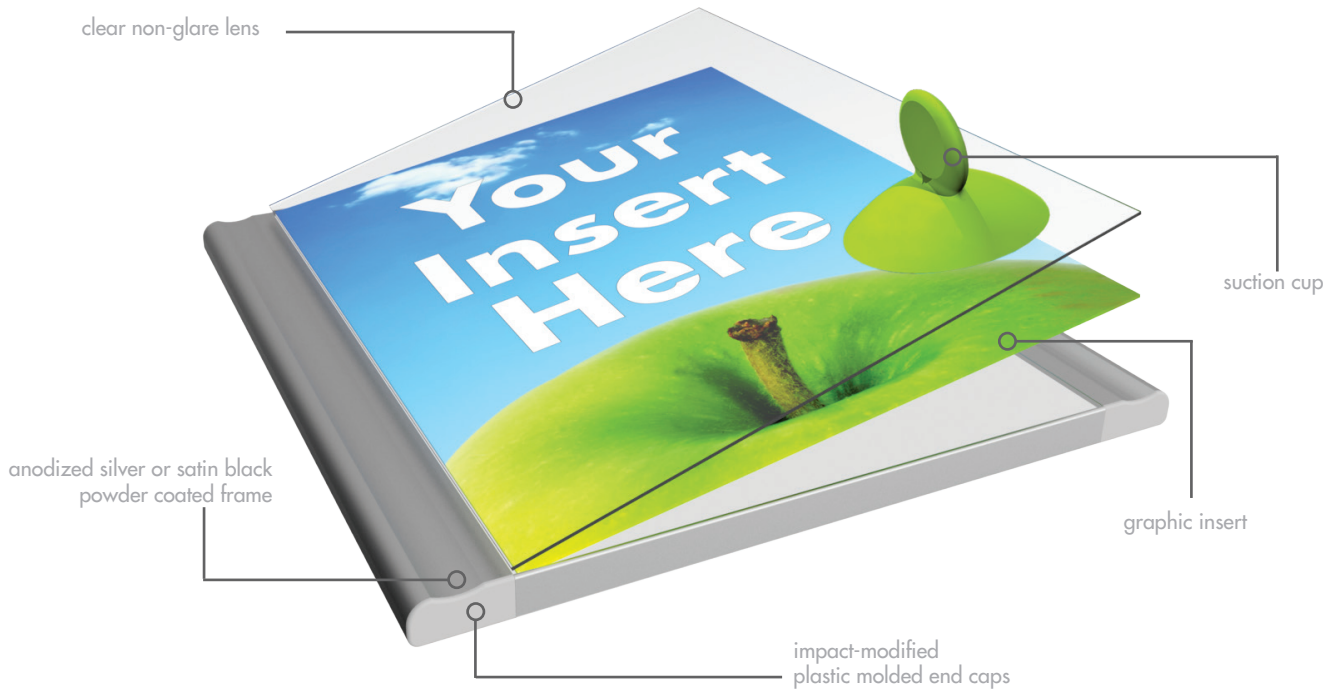

- \\ Aluminum frame extrusions are offered from 6" to 32" wide, at varying heights
- \\ Frames include round or square-shaped profile
- \\ Frames are available in anodized silver or powder-coated black
- \\ Plastic end caps are offered in gray or black
- \\ Frames come standard with a clear, non-glare lens
- \\ Tape mounting included, holes are an additional cost
- \\ Custom lengths available

■ Frame Size ■ Graphic Dims ■ Visible Area PREFIX: Add "FLAT-" to each listed code

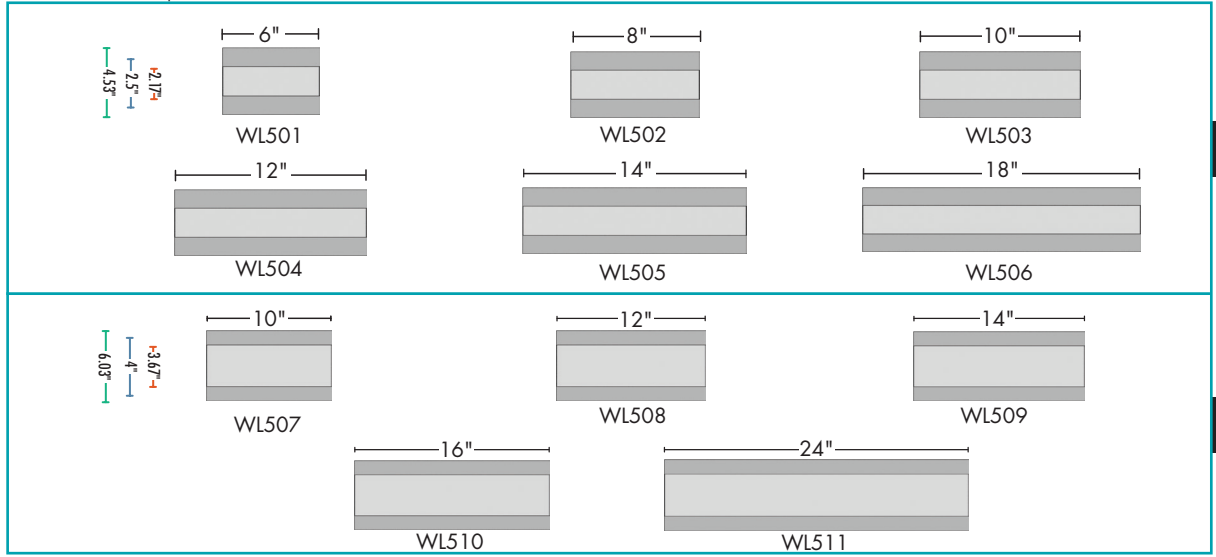

2.5

4

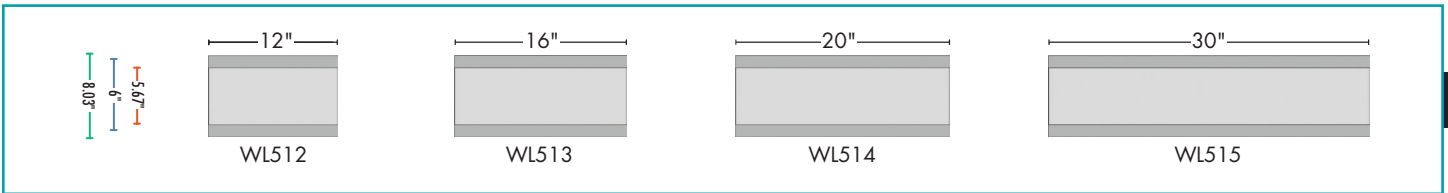

6

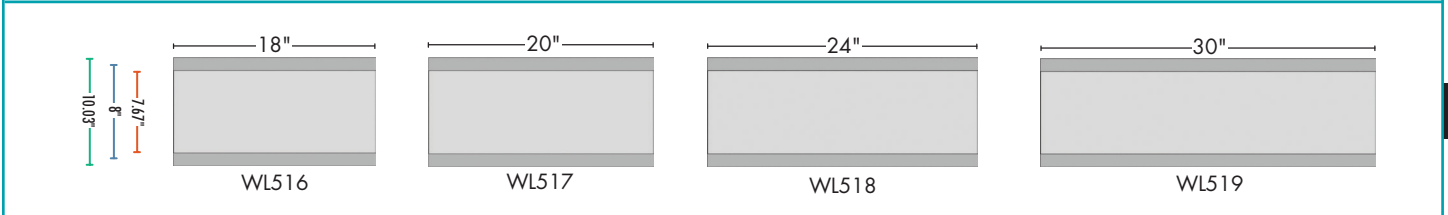

8

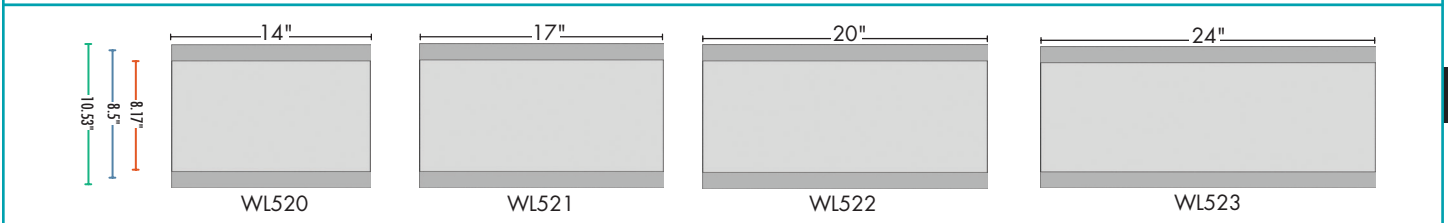

LETTER

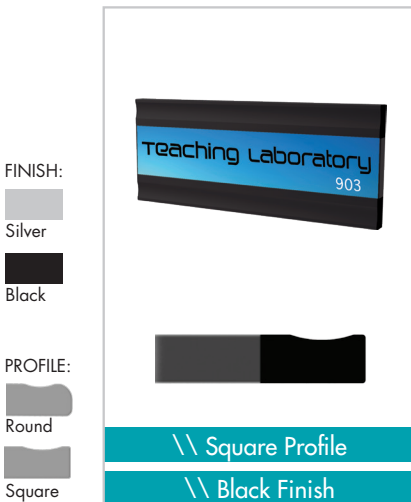

11

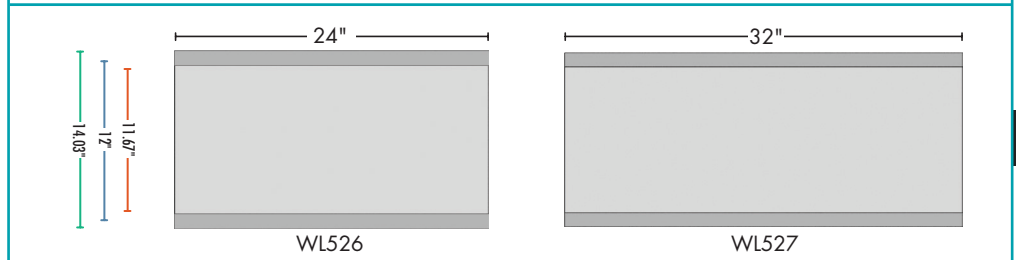

12



FINISH:



PROFILE:



■ Frame Size ■ Graphic Dims ■ Visible Area PREFIX: Add "FLAT-" to each listed code

<p>WP501</p>	<p>WP502</p>	<p>WP503</p>	<p>WP504</p>	<p>WP505</p>	<p>WP506</p>		
<p>WP507</p>	<p>WP508</p>	<p>WP509</p>	<p>WP510</p>	<p>WP511</p>	<p>WP512</p>	<p>WP513</p>	
<p>WP514</p>	<p>WP515</p>	<p>WP516</p>	<p>WP517</p>	<p>WP518</p>	<p>WP519</p>	<p>WP520</p>	
<p>WP521</p>	<p>WP522</p>	<p>WP523</p>	<p>WP524</p>	<p>WP525</p>	<p>WP526</p>	<p>WP527</p>	<p>WP528</p>

4

6

8

8.5

**LEFT & RIGHT
WALL SIGNS**

■ Frame Size ■ Graphic Dims ■ Visible Area

PREFIX: Add **"FLAT-"** to each listed code

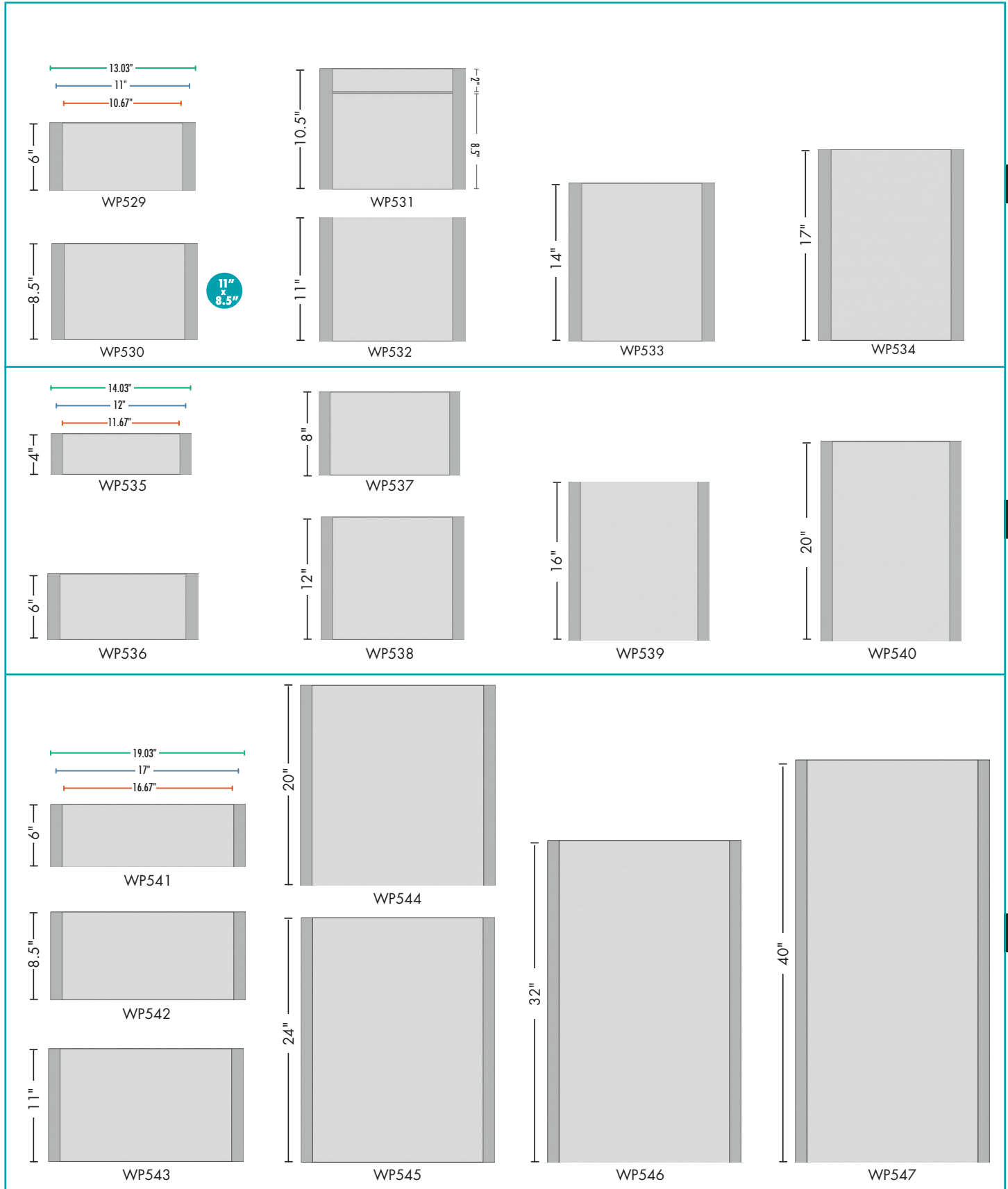

11

12

17

**LEFT & RIGHT
WALL SIGNS**

■ Frame Size ■ Graphic Dims ■ Visible Area

PREFIX: Add "FLAT-" to each listed code

20

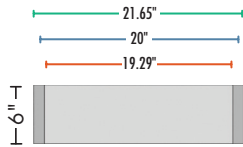

WP548



WP551



WP549

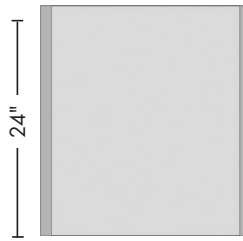

WP552

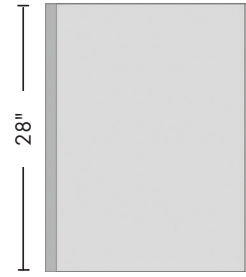

WP553

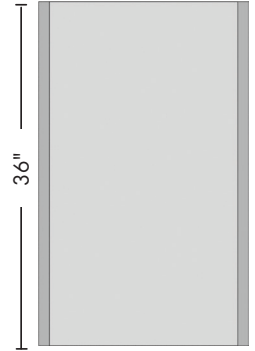

WP554

24

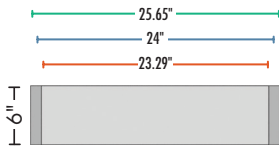

WP555

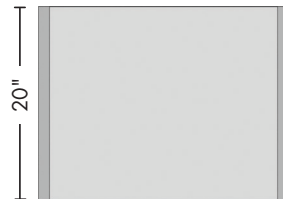

WP558



WP556

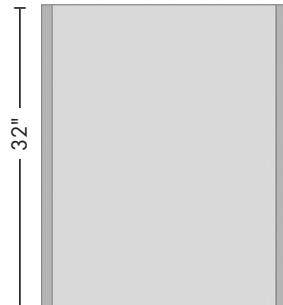

WP559

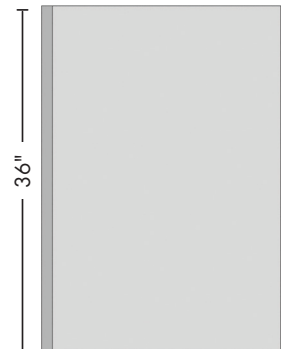

WP560

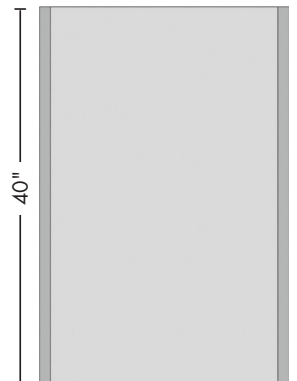

WP561

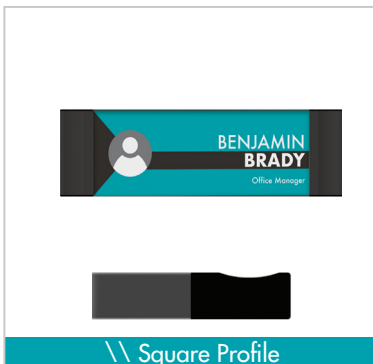

FINISH:



PROFILE:





PORTRAIT
DIRECTORIES

■ Frame Size ■ Graphic Dims ■ Visible Area

PREFIX: Add "FLAT-" to each listed code

11

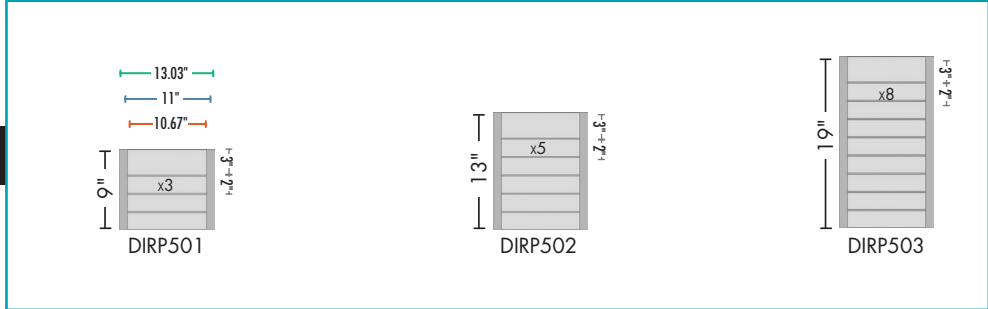

17

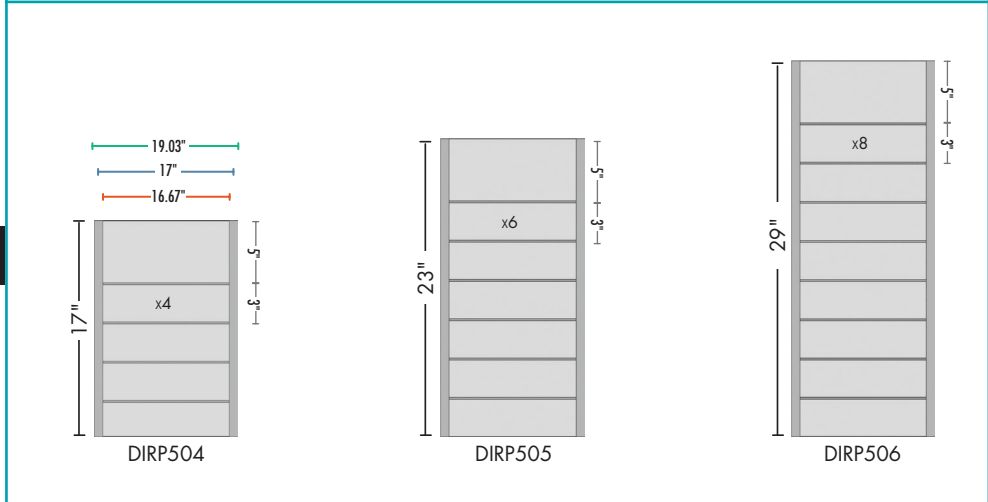

24

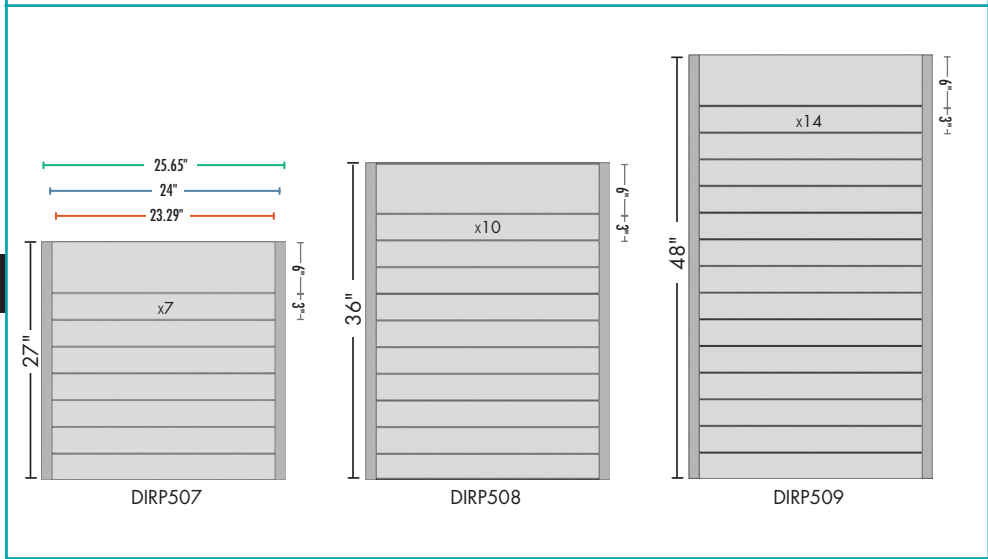





\\ Round Profile
\\ Black Finish



\\ Round Profile
\\ Silver Finish

- \\ Portrait style frame shape offered in choice of round or square-shaped
- \\ Frames located on the left & right sides
- \\ Configure the directory header to be placed as desired
- \\ Frame color choice of anodized silver or black
- \\ Dividing strips & end caps match the frame color of choice
- \\ Inserts can be replaced individually
- \\ Custom sizes available

- FINISH:
-  Silver
 -  Black
- PROFILE:
-  Round
 -  Square



11

17

24

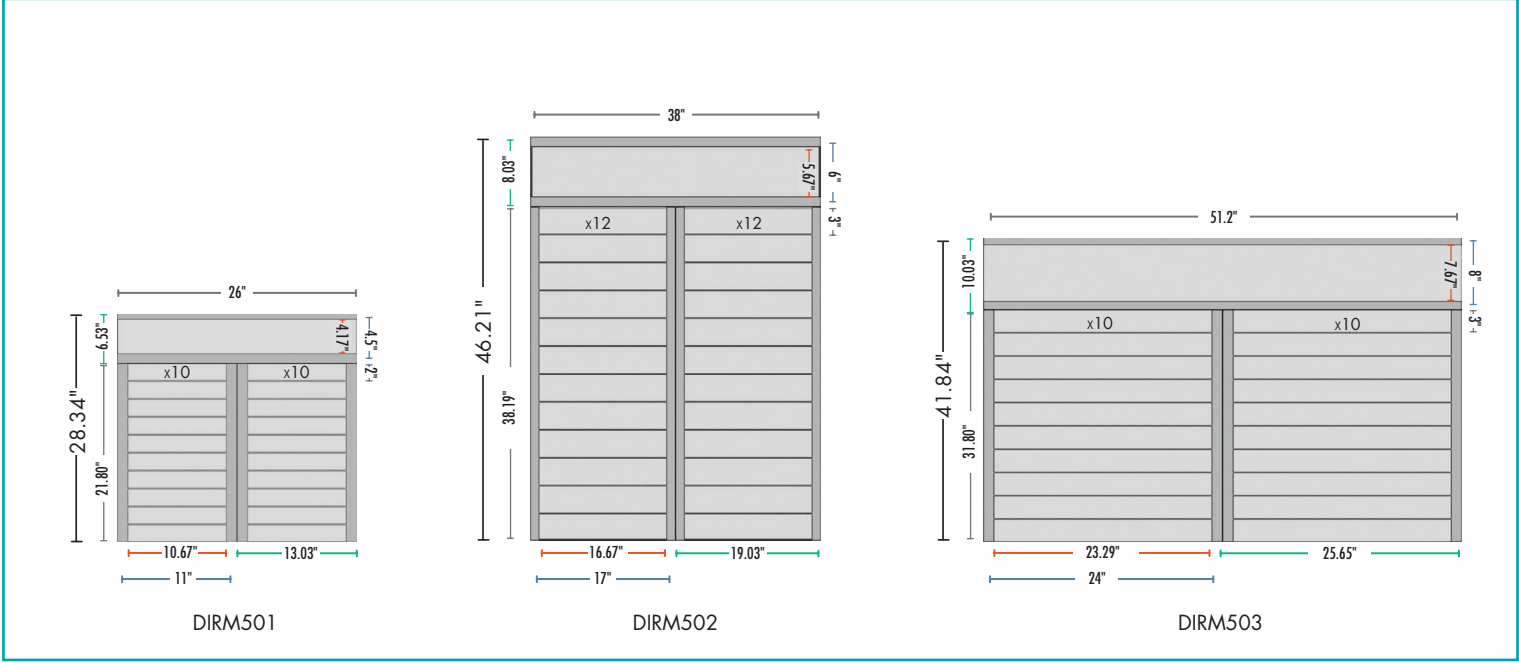

■ Frame Size ■ Graphic Dims ■ Visible Area PREFIX: Add "FLAT-" to each listed code

- \\ Combine multiple frames with a top & bottom header
- \\ Frames located on the left & right sides below the header
- \\ Frame color choice of anodized silver or black
- \\ Dividing strips & end caps match the frame color of choice
- \\ Inserts can be replaced individually
- \\ Custom sizes available

TOP & BOTTOM

PROJECTING

■ Frame Size ■ Graphic Dims ■ Visible Area

PREFIX: Add "FLAT-" to each listed code

4

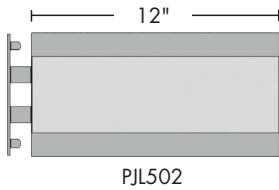
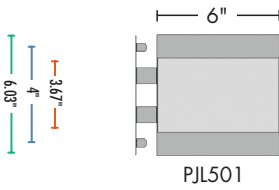

6

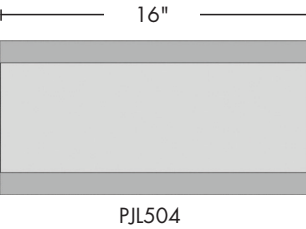
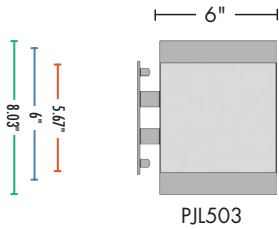

8

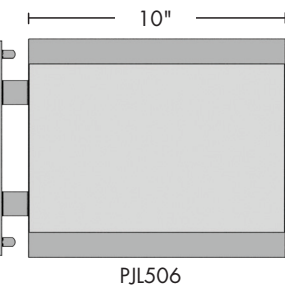
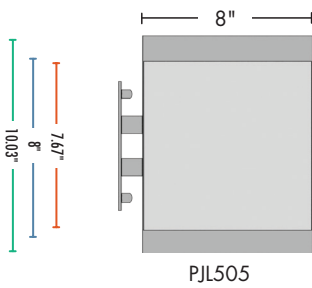

LETTER

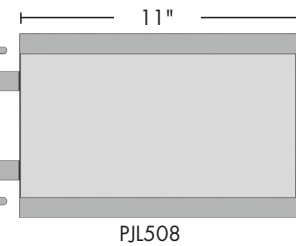
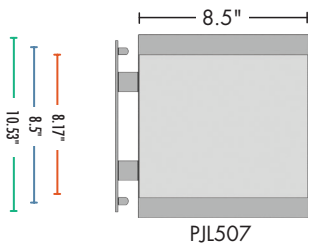

11

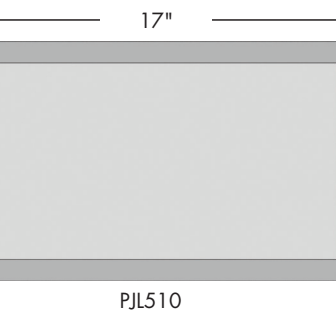
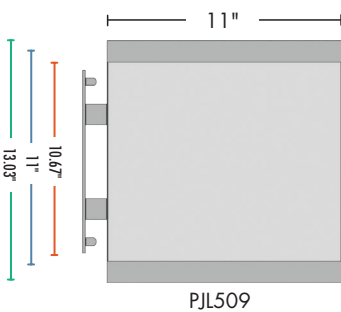

- \\ Double-sided flat projecting frames in landscape orientation
- \\ Frames located on top & bottom offered anodized in silver or black
- \\ Frames offered in choice of round or square-shaped
- \\ End caps match the frame color of choice
- \\ Inserts can be replaced
- \\ Comes with non-glare lens, fully assembled
- \\ Custom sizes available



FINISH:

- Silver
- Black

PROFILE:

- Round
- Square

■ Frame Size ■ Graphic Dims ■ Visible Area PREFIX: Add "FLAT-" to each listed code

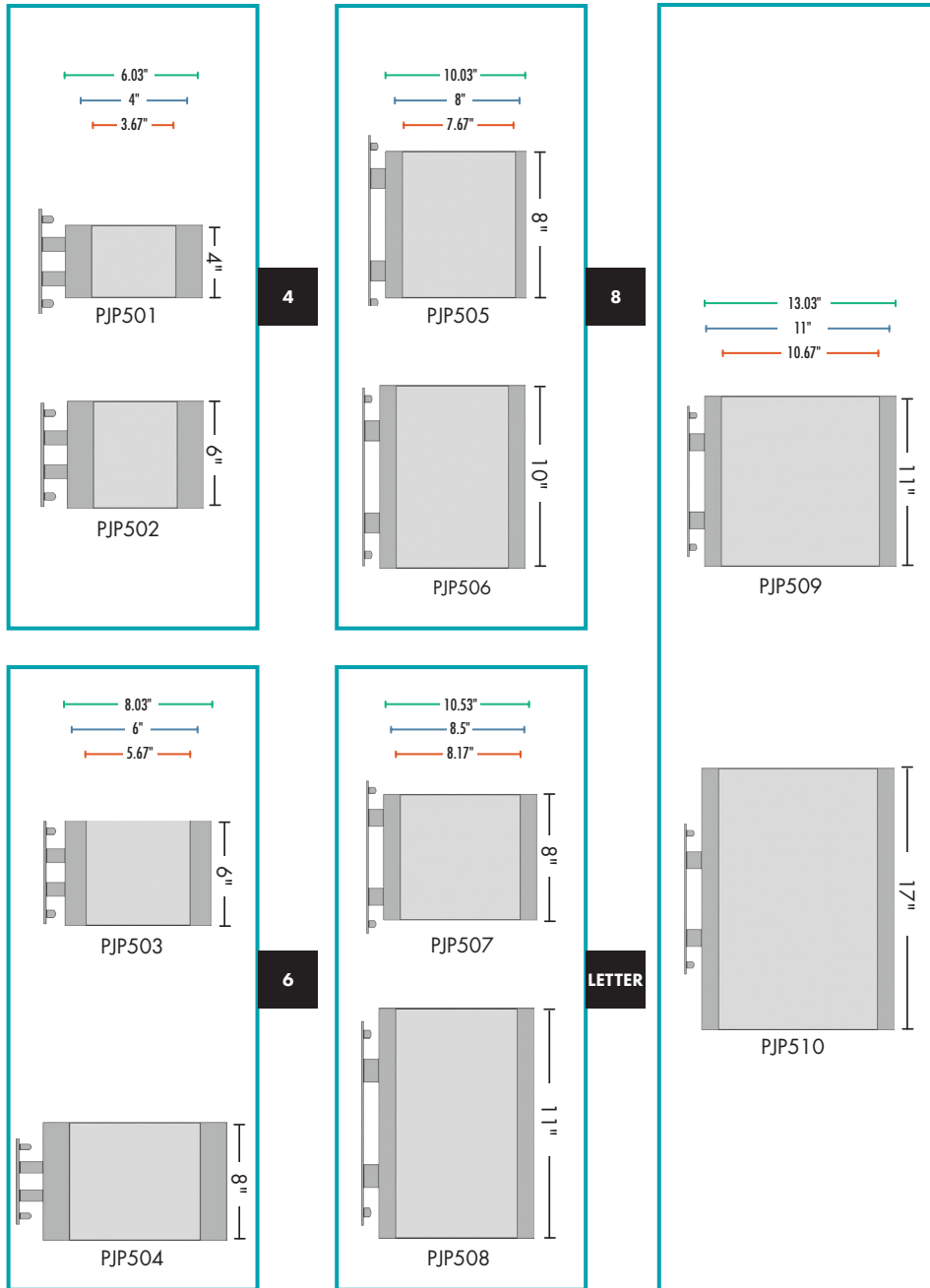

- \\ Double-sided flat projecting frames in portrait orientation
- \\ Frames located on left & right sides
- \\ Frame color choice of anodized silver or black
- \\ Frames offered in choice of round or square-shaped
- \\ End caps match the frame color of choice
- \\ Inserts can be replaced individually
- \\ Comes with non-glare lens, fully assembled
- \\ Custom sizes available

**TOP & BOTTOM
SUSPENDED**

■ Frame Size ■ Graphic Dims ■ Visible Area PREFIX: Add "FLAT-" to each listed code

4	20"	28"	32"
	SUSP501	SUSP502	SUSP503
	6.03" 3.7" 4"		
6	22"	26"	34"
	SUSP504	SUSP505	SUSP506
	8.03" 5.67" 6"		
8	20"	30"	38"
	SUSP507	SUSP508	SUSP509
	10.03" 7.67" 8"		
LETTER	11"	25"	40"
	SUSP510	SUSP511	SUSP512
	10.53" 8.17" 8.5"		
11	17"	24"	
	SUSP513	SUSP514	
	13.03" 10.67" 11"		
17	24"	36"	48"
	SUSP515	SUSP516	SUSP517
	19.03" 16.67" 17"		

- \\ Double-sided flat projecting frames in landscape orientation
- \\ Frames located on top & bottom offered in anodized silver or black
- \\ Frames offered in choice of round or square-shaped
- \\ End caps match the frame color of choice
- \\ Inserts can be replaced individually
- \\ Comes with non-glare lens, fully assembled
- \\ Custom sizes available

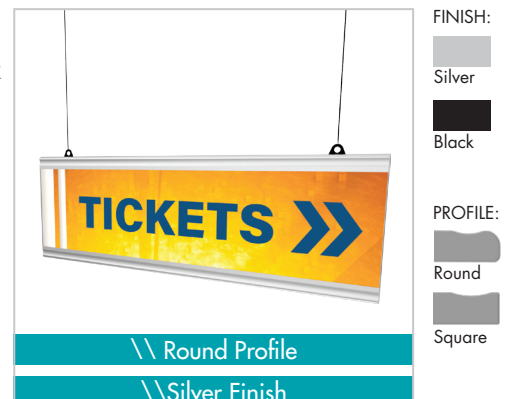

**TRIANGULAR
PROJECTING**

- \\ Triangular frame shape offered in choice of round or square-shaped
- \\ Frames located on the left & right sides
- \\ Configure the directory header to be placed as desired
- \\ Frame color choice of anodized silver or black
- \\ Inserts can be replaced individually
- \\ Custom sizes available

■ Frame Size ■ Graphic Dims ■ Visible Area

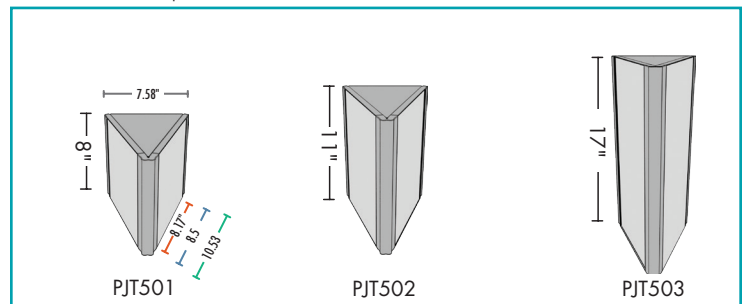

PREFIX: Add "FLAT-" to each listed code

DESK FRAMES

DESK

- \\ High quality standing desk frames with frames on left & right sides
- \\ Frame color choice of anodized silver or black
- \\ Frame shape offered in choice of round or square-shaped
- \\ Clear, non-glare lens and suction cup included
- \\ Custom sizes available

■ Frame Size ■ Graphic Dims ■ Visible Area PREFIX: Add "FLAT-" to each listed code

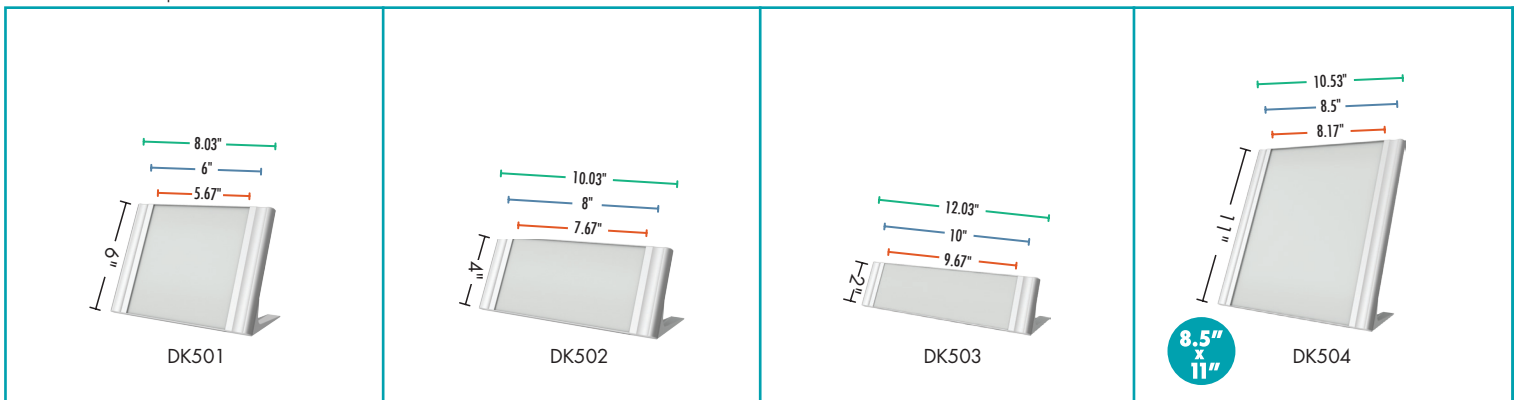



CURVED SYSTEM



- \\ Aluminum frame extrusions are offered from 4" to 48" wide, at varying heights
- \\ Frames are available in anodized silver or powder coated black
- \\ Plastic end caps are offered in gray or black
- \\ Frames come standard with a clear, non-glare lens
- \\ Tape mounting included, holes are an additional cost
- \\ Custom lengths available





Frame Dimension	Graphic Dimension	Sign ID
4"	2-1/8"	WL1
6"	2-3/8"	WL2
8"	2-7/8"	WL3
10"	3-1/8"	WL4
12"	3-5/8"	WL5
14"	4-1/8"	WL6
16"	4-5/8"	WL7
18"	5-1/8"	WL8
5"	3-3/4"	WP4
6"	3-9/8"	WP5
8"	4-1/4"	WP6
10"	4-7/8"	WL9
12"	5-1/4"	WL10
14"	5-7/8"	WL11
16"	6-1/4"	WL12
18"	6-7/8"	WL13
20"	7-1/4"	WL14
22"	7-7/8"	WL15
10"	4-17/32"	WL16
12"	4-7/2"	WL17
14"	5-1/8"	WL18
16"	5-5/8"	WL19
20"	6-1/4"	WL20
24"	6-7/8"	WL21
12"	5-9/8"	WL22
14"	5-3/4"	WL23
16"	6-1/8"	WL24
20"	6-7/8"	WL25
24"	7-1/4"	WL26
26"	7-7/8"	WL27
12"	7-3/4"	WL28
16"	8-1/8"	WL29
18"	8-5/8"	WL30
20"	9-1/4"	WL31
24"	9-7/8"	WL32
28"	10-3/4"	WL33
11"	8-17/32"	WP37
14"	8-6/4"	WL35
17"	9-1/8"	WL36
20"	9-7/8"	WL37
24"	10-3/4"	WL38
8.5"	11-1/16"	WP41
14"	11-1/9"	WL40
17"	11-5/8"	WL41
20"	12-1/8"	WL42
22"	12-5/8"	WL43
28"	13-1/4"	WL44
10"	12-1/9"	WL45
12"	12-5/8"	WL46
14"	13-1/4"	WL47
18"	14-1/8"	WL48
20"	14-7/8"	WL49
28"	16-1/4"	WL50
32"	17-1/8"	WL51
17"	17-1/9"	WL52
24"	18-1/4"	WL67
36"	19-1/8"	WP70
18"	17-15/16"	WL53
24"	18-7/8"	WP79
36"	19-3/4"	WP82
24"	24.0625"	WP85
36"	24.0625"	WP86
48"	24.0625"	WP87



blue insert slides left & right



partition pins used to secure frame to fabric wall

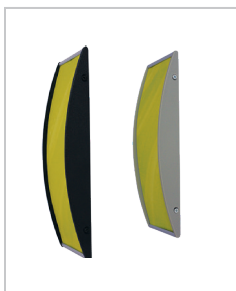

All length measurements apply to the extrusion only and exclude the end caps.

60

100

120

150

200

LETTER

11

12

17

18

24

LEFT-TO-RIGHT WALL SIGNS

- \\ High quality, left-to-right curved frames
- \\ Frames are available in anodized silver or powder coated black
- \\ Frames come standard with a clear, non-glare lens
- \\ Tape mounting included, holes are an additional cost
- \\ Frames are ADA-compatible
- \\ Custom lengths available

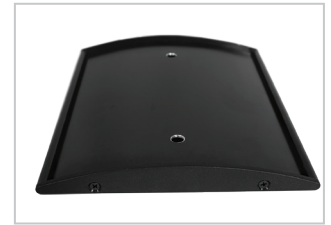
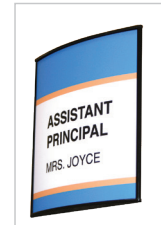
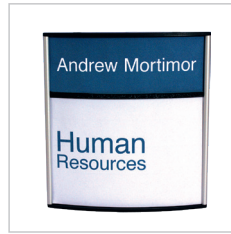

comes fully assembled



graphic dimension

frame dimension

100	$3\text{-}\frac{3}{4}\text{'}$ 3.93' WP1	3' WP2	4' WP3	4.1875' 4' WP311	5' WP4	5.1875' 5' WP411	6' WP5	6.1875' 6' WP511	8' WP6				
120	$4\text{-}\frac{17}{32}\text{'}$ 4.72' WP7	3' WP8	4' WP9	4.1875' 4' WP91	5' WP10	5.1875' 5' WP101	6' WP11	6.1875' 6' WP111	7' WP12	8' WP13			
150	$5\text{-}\frac{3}{4}\text{'}$ 5.90' WP14	3' WP15	4' WP16	4.1875' 4' WP161	5' WP17	6' WP18	6.1875' 6' WP181	8' WP19	8.1875' 8' WP191	8.5' WP20	9' WP21		
200	$7\text{-}\frac{3}{4}\text{'}$ 7.87' WP22	4' WP23	4.1875' 4' WP231	5' WP24	6' WP25	6.1875' 6' WP251	8' WP26	8.1875' 8' WP261	10' WP27	10.1875' 10' WP271	12' WP28	16' WP29	18' WP30
LETTER	$8\text{-}\frac{17}{32}\text{'}$ 8.64' WP31	5.5' WP32	6' WP33	8' WP34	8.1875' 8' WP341	8.5' WP35	10' WP36	10.1875' 10' WP361	11' WP37	11.1875' 11' WP371	13.1875' 13' WP372	16' WP38	
11	$11\text{-}\frac{1}{16}\text{'}$ 11.19' WP40	8.5' WP41	8.6875' 8.5' WP4111	10' WP42	10.6875' 10.5' WP421	11' WP43	13' WP44	14' WP45	17' WP46	20' WP47			

All length measurements apply to the extrusion only and exclude the end caps.

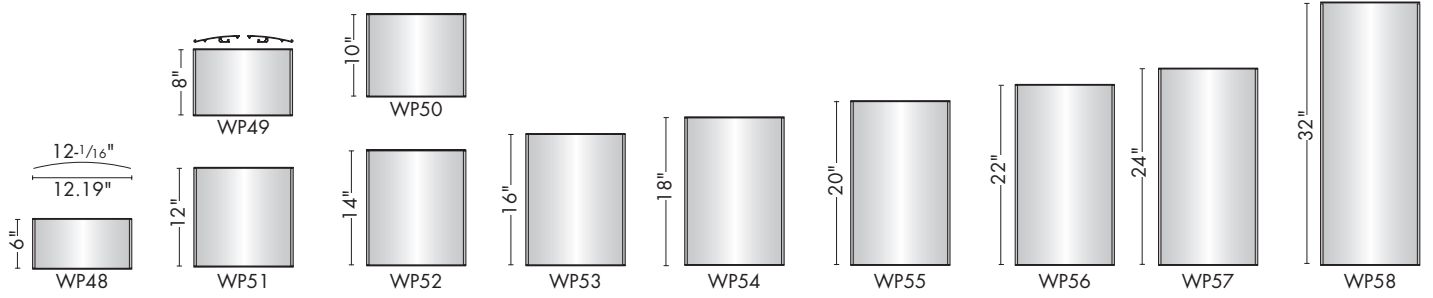

12

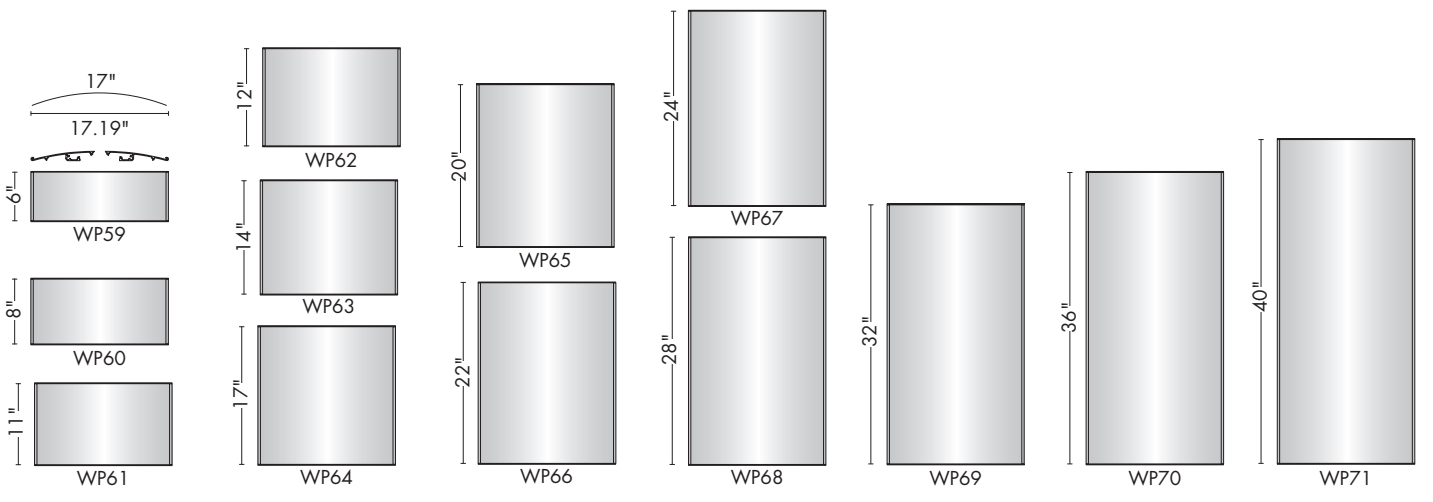

17

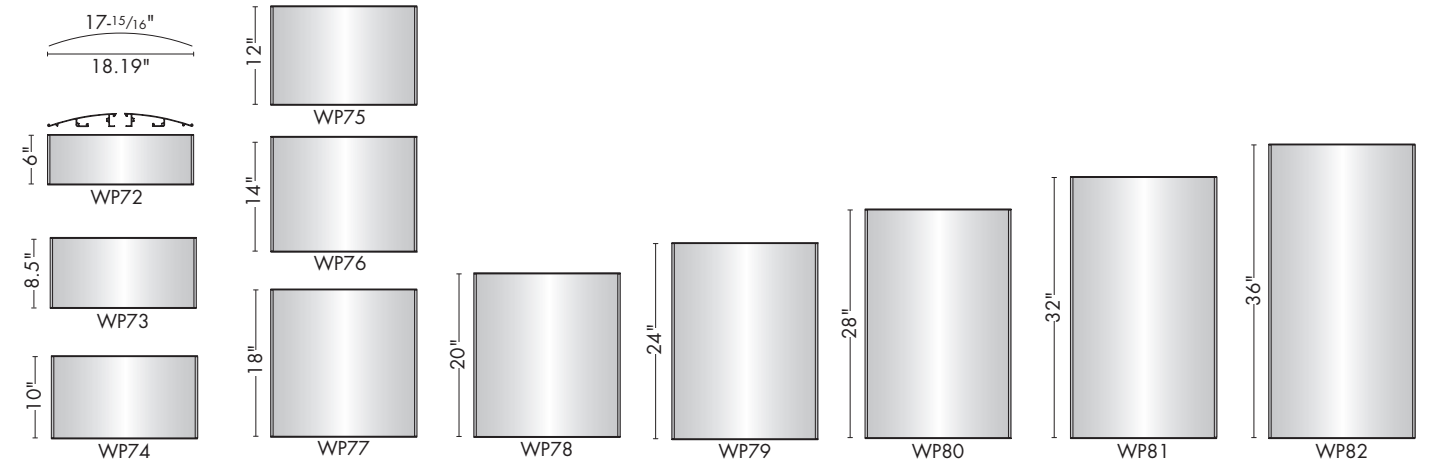

18

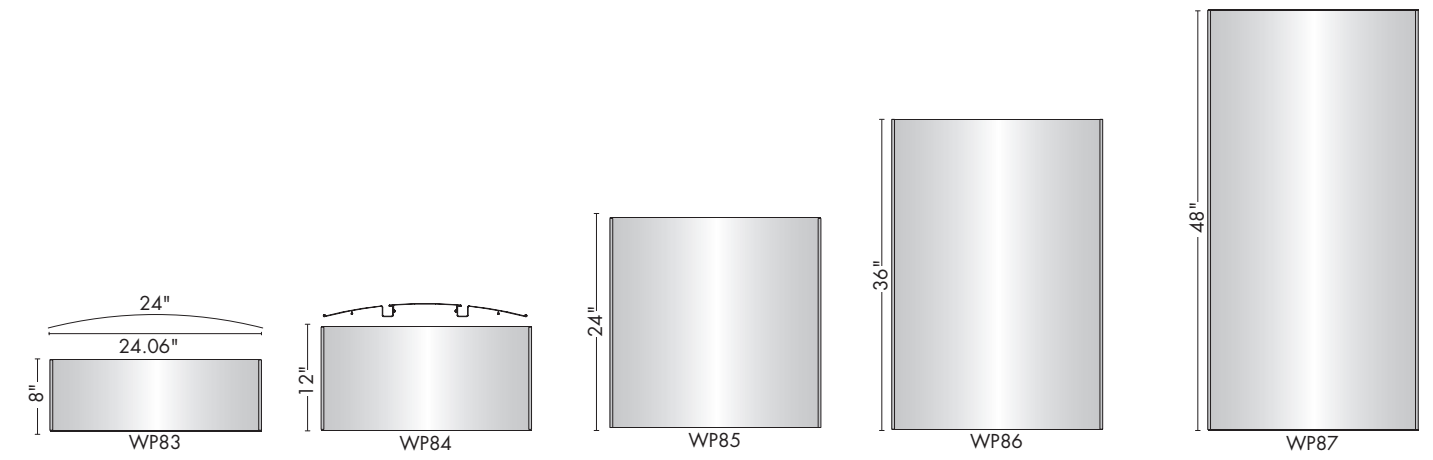

24

All length measurements apply to the extrusion only and exclude the end caps.

ADA lenses available for select wall frames only. Minimum of ten ADA lenses required per order.

DIRP SERIES
DIRECTORIES

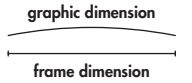

11

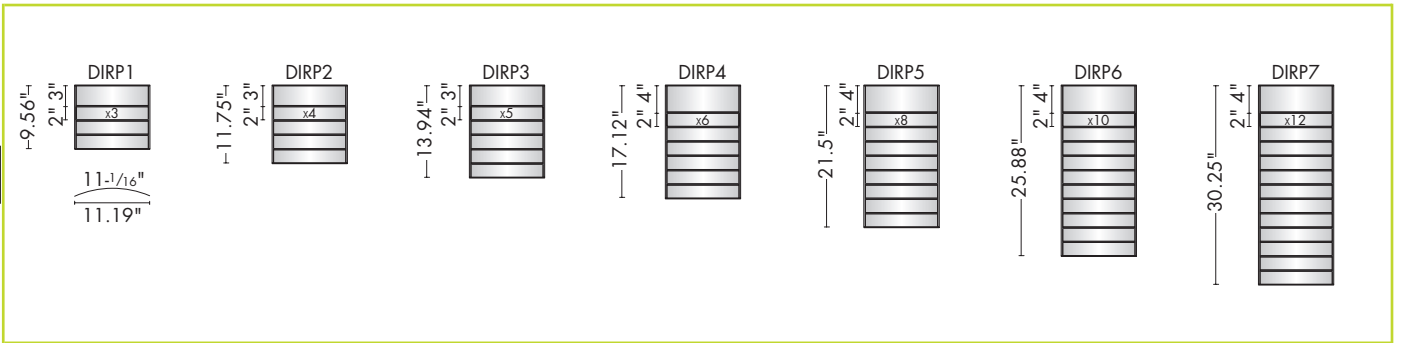

17

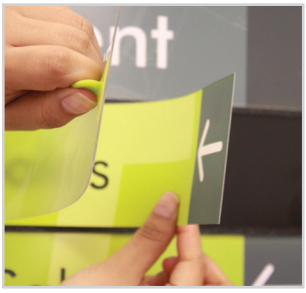
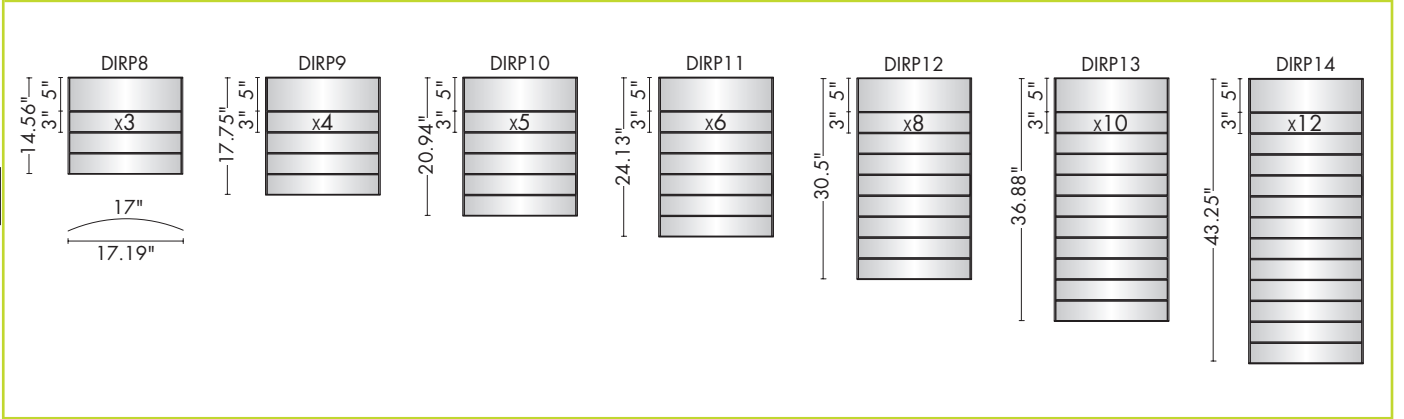

graphic is easily inserted before clear, non-glare lens

24

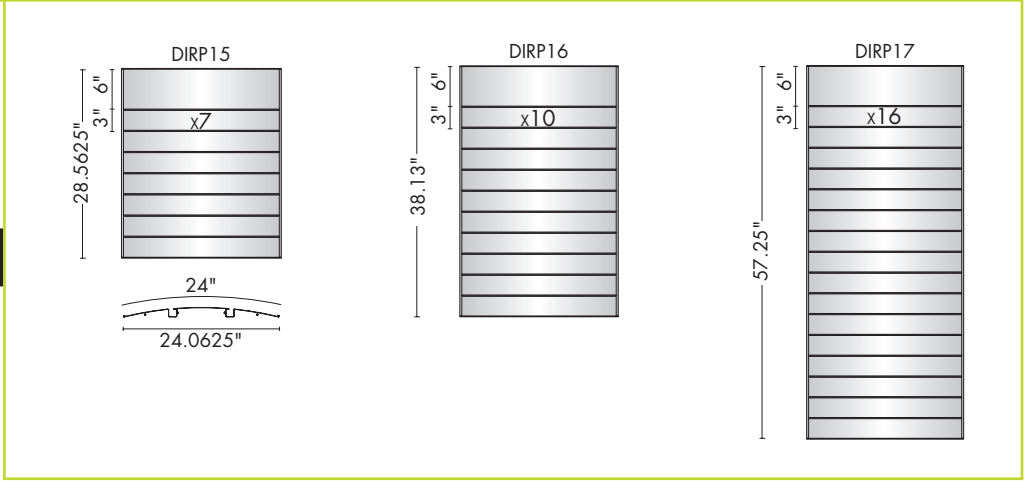

All length measurements apply to the extrusion only and exclude the end caps.

- \\ Dividing strips adhere to the frame and can be placed anywhere desired
- \\ End caps located on top & bottom
- \\ Inserts can be replaced individually
- \\ Custom frame combinations & lengths available



- \\ Combine multiple vertical frames with a top-to-bottom curve header
- \\ Vertical frames come with black dividing strips
- \\ Inserts can be replaced individually
- \\ Choice of black or gray end caps
- \\ Custom frame combinations & lengths available

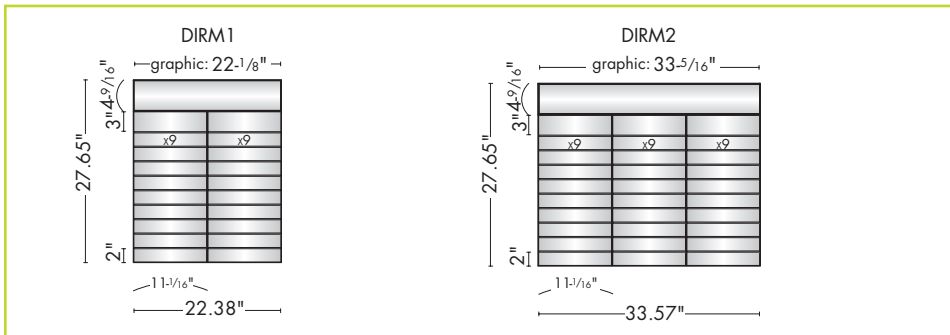

EAST WING LEVEL 1		
103	ADMINISTRATION	RESPIRATORY THERAPY 112
104	ADMISSIONS/CASHIER	REHABILITATION OFFICE 113
105	PATIENT RELATIONS OFFICE	PURCHASING/RECEIVING 114
106	PHARMACY	FAMILY WAITING ROOM 115
107	RADIOLOGY	ENVIRONMENTAL OFFICE 116
108	PHYSICAL THERAPY	SOCIAL SERVICES 117
109	ULTRASONOGRAPHY	GIFT SHOP 118
110	PATHOLOGY	CAFE 119
111	CT SCAN	HUMAN RESOURCES 120

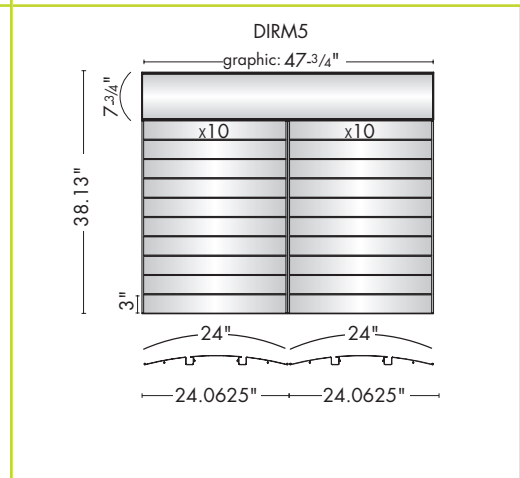
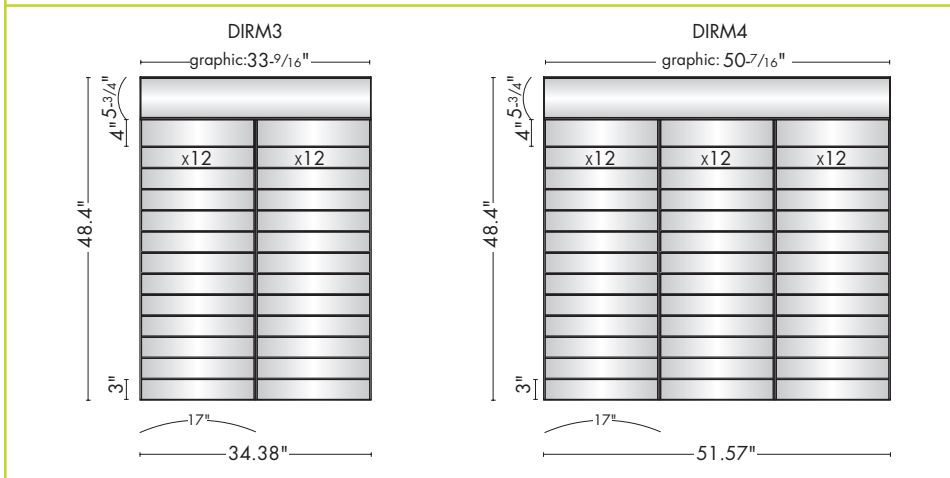

All length measurements apply to the extrusion only and exclude the end caps.

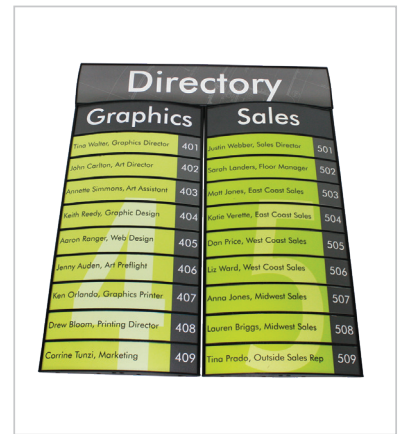
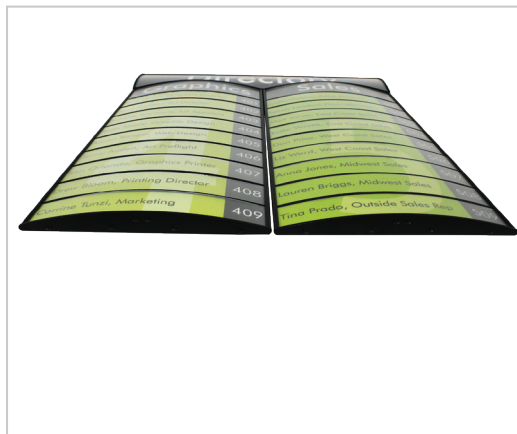

the non-glare lens is easily taken off with the suction cup for individual graphic replacement

DIRL SERIES

DIRECTORIES

- \\ Consists of multiple top-to-bottom curved frames combined
- \\ End caps on left & right sides
- \\ Comes as separate frames to mount to the wall individually
- \\ Choice of black or gray end caps
- \\ Custom frame combinations & lengths available

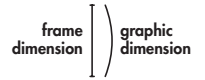

100	 DIRL1	 DIRL2	 DIRL3	
200	 DIRL4	 DIRL5	 DIRL6	
LETTER	 DIRL7	 DIRL8	 DIRL9	

All length measurements apply to the extrusion only and exclude the end caps.

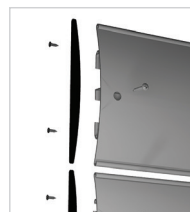
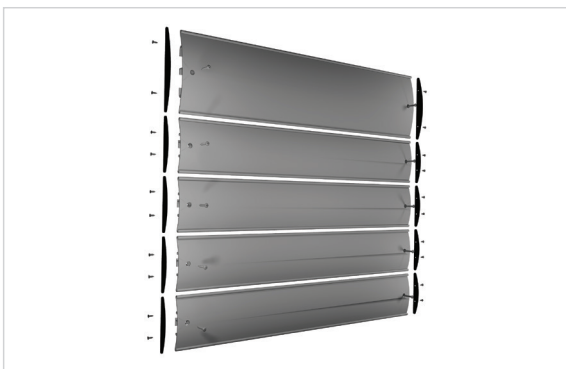

each frame allows for unique insert, available in custom widths up to 8'



the non-glare lens is easily taken off with the suction cup for individual graphic replacement

PJL

PROJECTING

- \\ Double-sided, comes in landscape or portrait positions
- \\ End caps on left & right sides
- \\ Anodized silver or powder coated black frames
- \\ Choice of black or gray end caps
- \\ Comes with clear non-glare lens
- \\ Custom lengths available

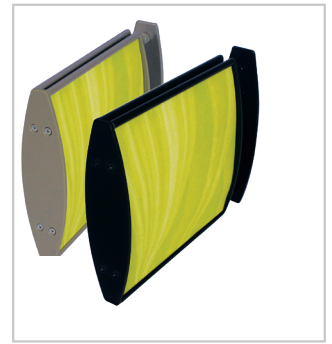

graphic dimension | frame dimension

100	<p>PJL1</p>	<p>PJL2</p>	<p>PJL3</p>	<p>PJL31</p>
150	<p>PJL4</p>	<p>PJL5</p>	<p>PJL6</p>	<p>PJL61</p>
200	<p>PJL7</p>	<p>PJL8</p>	<p>PJL9</p>	
LETTER	<p>PJL10</p>	<p>PJL11</p>	<p>PJL12</p>	
11	<p>PJL13</p>	<p>PJL14</p>	<p>PJL15</p>	

All length measurements apply to the extrusion only and exclude the end caps.

- \\ Flat, double-sided, projecting signs
- \\ Idea for cut vinyl applications
- \\ Sliver finish with black plastic end caps
- \\ Comes fully assembled
- \\ Custom lengths available

PJF
PROJECTING

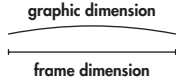

5" 4" PJF1

7.5" 4" PJF2

10" 4" PJF3

12" 4" PJF4

14" 4" PJF5

16" 4" PJF6

3-3/4" 3.93" PJ1

4.75" PJ1

5.5" PJ2

100

7-3/4" 7.87" PJ5

8" PJ5

10" PJ6

200

11-1/16" 11.19" PJ9

11" PJ9

14" PJ10

17" PJ11

11

5-3/4" 5.90" PJ3

6" PJ3

6.75" PJ4

150

8-17/32" 8.64" PJ7

8" PJ7

8.5" x 11" PJ8

11" PJ8

LETTER

All length measurements apply to the extrusion only and exclude the end caps.

TOP-TO-BOTTOM

SUSPENDED

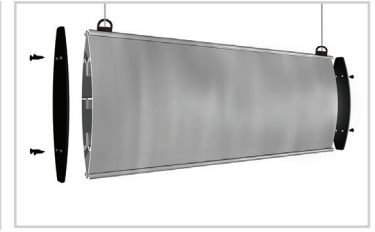

- \\ Suspended signs combine back-to-back extrusions
- \\ Ideal for cut vinyl applications
- \\ Choice of black or gray end caps
- \\ Comes with clear non-glare lens, fully assembled
- \\ Custom lengths available



frame dimension | graphic dimension

60	SUSP1	SUSP2	SUSP3	SUSP4	
	2-1/8" (2.36")	16"	20"	24"	
	14"	16"	20"	24"	
100	SUSP5	SUSP6	SUSP7	SUSP8	
	3-3/4" (3.93")	24"	28"	32"	
	21"	24"	28"	32"	
120	SUSP9	SUSP10	SUSP11	SUSP12	
	4-17/32" (4.72")	26"	30"	34"	
	22"	26"	30"	34"	
150	SUSP13	SUSP14	SUSP15	SUSP16	
	5-3/4" (5.9")	28"	33"	38"	
	23"	28"	33"	38"	
200	SUSP17	SUSP18	SUSP19	SUSP20	
	7-3/4" (7.87")	26"	32"	38"	
	20"	26"	32"	38"	
LETTER	SUSP21	SUSP22	SUSP23	SUSP24	
	8-17/32" (8.64")	20"	25"	40"	
	11"	20"	25"	40"	
11	SUSP241	SUSP242	SUSP243	SUSP244	
	11-1/16" (11.19")	17"	24"	36"	
	14"	17"	24"	36"	
17	SUSP245	SUSP246	SUSP247	SUSP248	SUSP249
	17" (17.19")	24"	28"	36"	48"
	17"	24"	28"	36"	48"

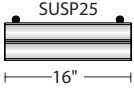
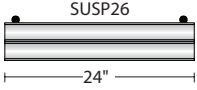
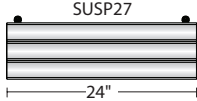
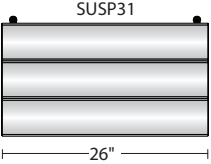
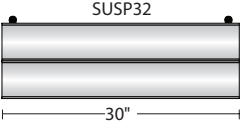
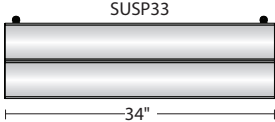
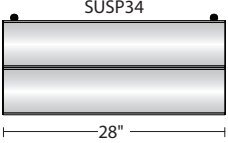
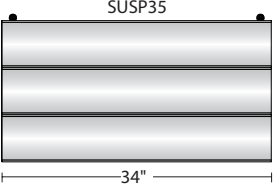
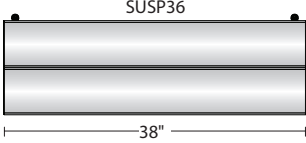
All length measurements apply to the extrusion only and exclude the end caps.

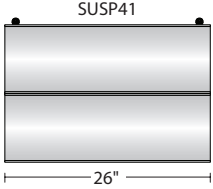
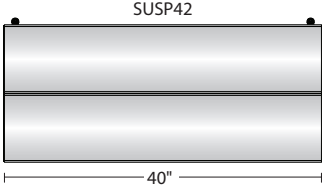
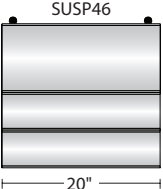
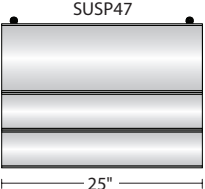
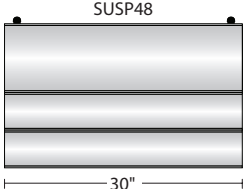
			2.1/8" 2.36"	60 60 60
			4.72" 4.17/32"	120 120
			5.90" 5.3/4"	150 150
			8.64" 8.17/32"	LETTER LETTER
			8.64" 8.17/32" 4.72"	LETTER 120 120

All length measurements apply to the extrusion only and exclude the end caps.



24" left-to-right curve



17" left-to-right curve

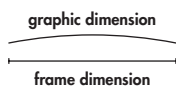

LEFT-TO-RIGHT

SUSPENDED

- \\ Available with a left-to-right curve orientation in both 24" and 17" widths
- \\ Combined with the height of your choice
- \\ Silver or black curved aluminum face, choice of black or grey end caps
- \\ Comes complete with a clear, non-glare lens
- \\ Comes fully assembled

PJT

TRIANGULAR

- \\ Triangular frames offered in two silver or black aluminum curved faces
- \\ Black powder-coated steel end caps
- \\ Mounting plates come standard with keyholes and round holes
- \\ Available in eight standard heights
- \\ Custom lengths available

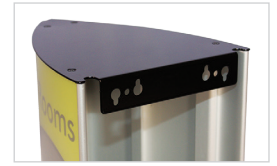
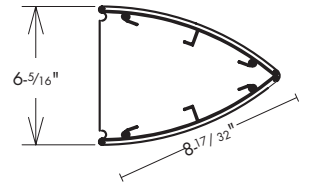

 PJT1	 PJT2	 PJT3	 PJT4	 PJT5	 PJT6	 PJT7	 PJT8
----------	----------	----------	----------	----------	----------	----------	----------

TR

TRIANGULAR

- \\ The triangular aluminum extruded body with impact-modified molded plastic end caps
- \\ Allows for wall or ceiling mount
- \\ Visible from two directions
- \\ Custom lengths available

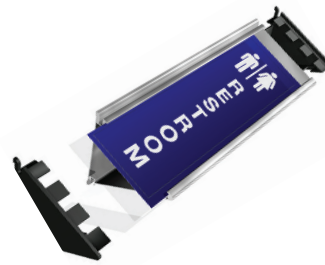

 TR1	 TR2	 TR3	 TR4	 TR5	 TR6	 TR7
---------	---------	---------	---------	---------	---------	---------

All length measurements apply to the extrusion only and exclude the end caps.

DKP SERIES

DESK

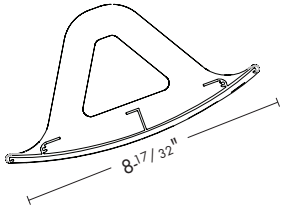

The **DKP series** of standing desk frames consists of high quality, powder-coated black anodized silver extruded aluminum body with a black plastic top cap and black steel foot plate. Its clear, non-glare lens and suction cup come standard. Custom lengths available.

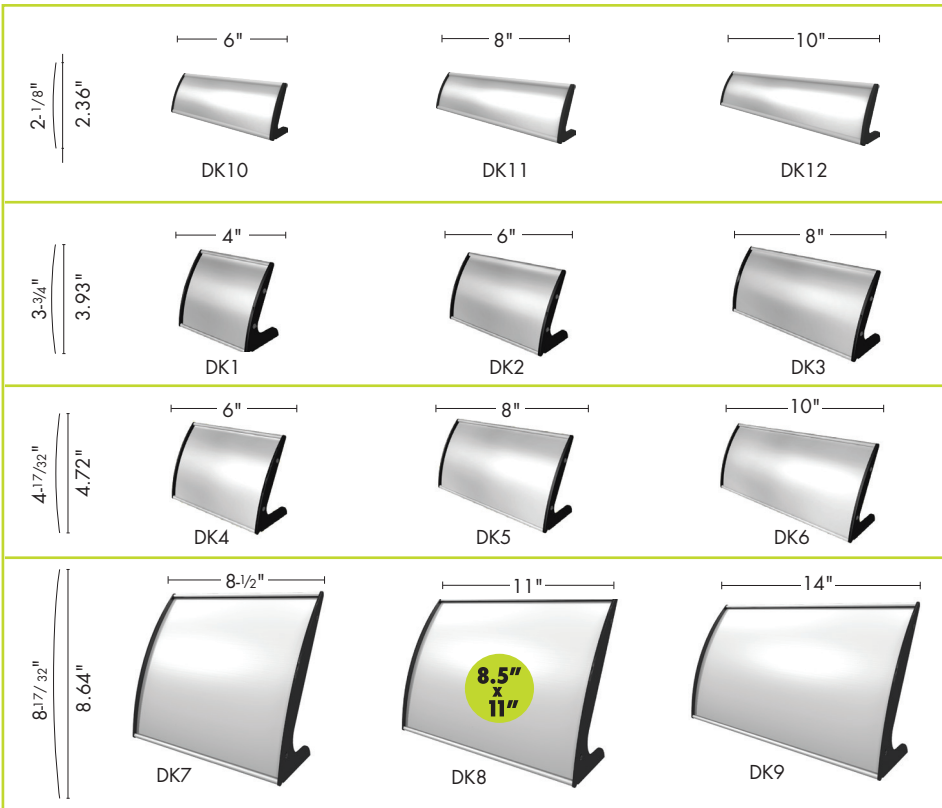
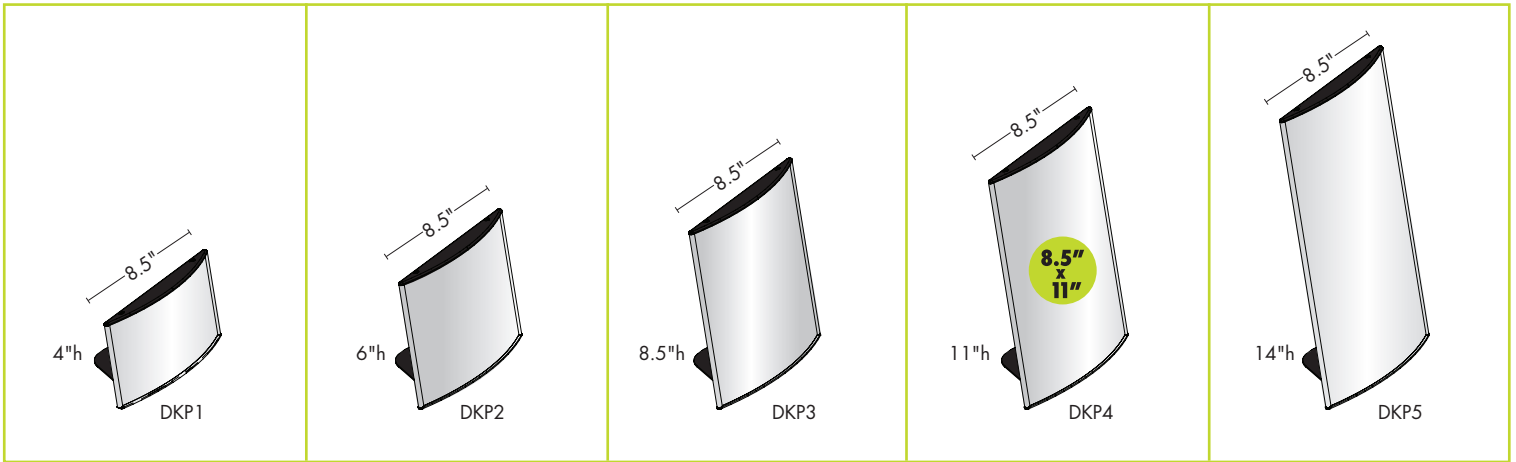

DK SERIES

DESK

60

100

120

LETTER



The **DK series** of standing desk frames offers impact-modified plastic molded end caps that double as feet for desk or table top use and a high quality, extruded aluminum body with anodized silver or satin powder-coated black finish. Clear, non-glare lens comes standard. Custom lengths available.

All length measurements apply to the extrusion only and exclude the end caps.

ACRYLIC

DESK

The **DKS** series of standing desk frames features two clear acrylic protective plates that protect your print and brushed silver aluminum support feet for a sharp and modern look. Comes in two standard sizes.

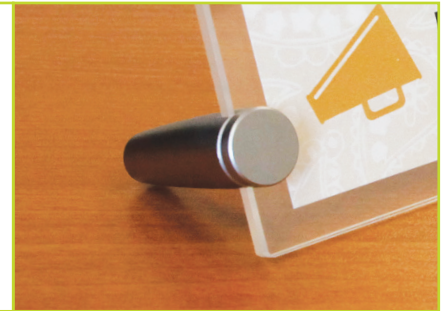
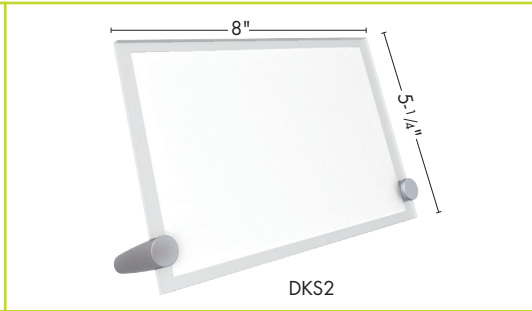
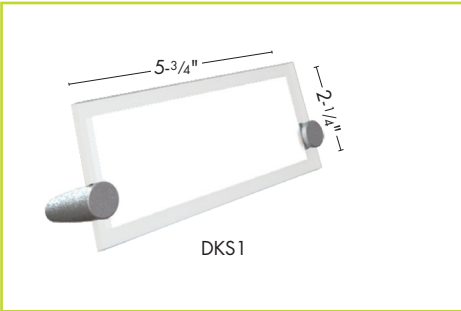

silver aluminum feet detach from clear acrylic plates for easy graphic insertion

CONCAVE

DESK

These sleekly designed **CONCAVE** desk frames are constructed of high-quality extruded aluminum. The lens slides in and out for easy print replacements. Comes standard in anodized silver or satin powder-coated black finish in two standard sizes.



Dimensions above are graphic sizes only.

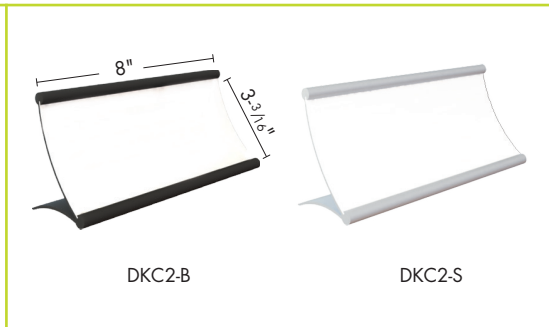
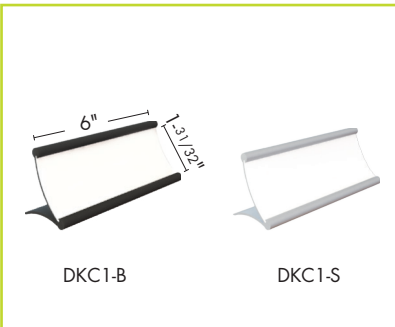

lens and graphic slide out for easy replacement

The **DKD** line of desk frames combines a stable domed, brushed silver aluminum holder with an elegant protective acrylic folded pocket providing a modern double-sided option and allows easy graphic changes. Comes in four standard sizes.

Dimensions above are graphic sizes only.



DESK



SIZE	PORTRAIT	LANDSCAPE	# OF SUPPORT FEET
8.5" x 11"	DKSNAP-1-P	DKSNAP-1-L	1
11" x 14"	DKSNAP-2-P	DKSNAP-2-L	1
11" x 17"	DKSNAP-11-P	DKSNAP-11-L	1
12" x 18"	DKSNAP-12-P	DKSNAP-12-L	1
14" x 22"	-	DKSNAP-3-L	2
16" x 20"	DKSNAP-4-P	DKSNAP-4-L	2
20" x 24"	-	DKSNAP-5-L	2

The **DK Snap** desk frames are available in a range of sizes and in black or silver. These front-loading desk frames snap open for quick and easy graphic changes. Includes clear non-glare protective lens.



SNAP-EDGE

TRAPPA

- \\ Silver or black anodized finish with precision mitered corners
- \\ Snaps open for quick and easy graphic changes
- \\ No tools required
- \\ Aluminum extrusions mounted to a high-impact polystyrene backer
- \\ Comes with clear non-glare lens, mounting hardware
- \\ Protective sheet material: PVC

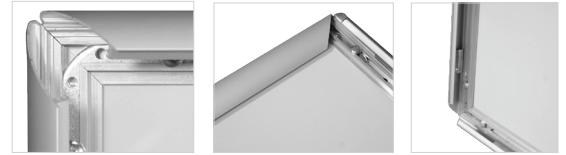

Dimensions below refer to size of printed graphic only.

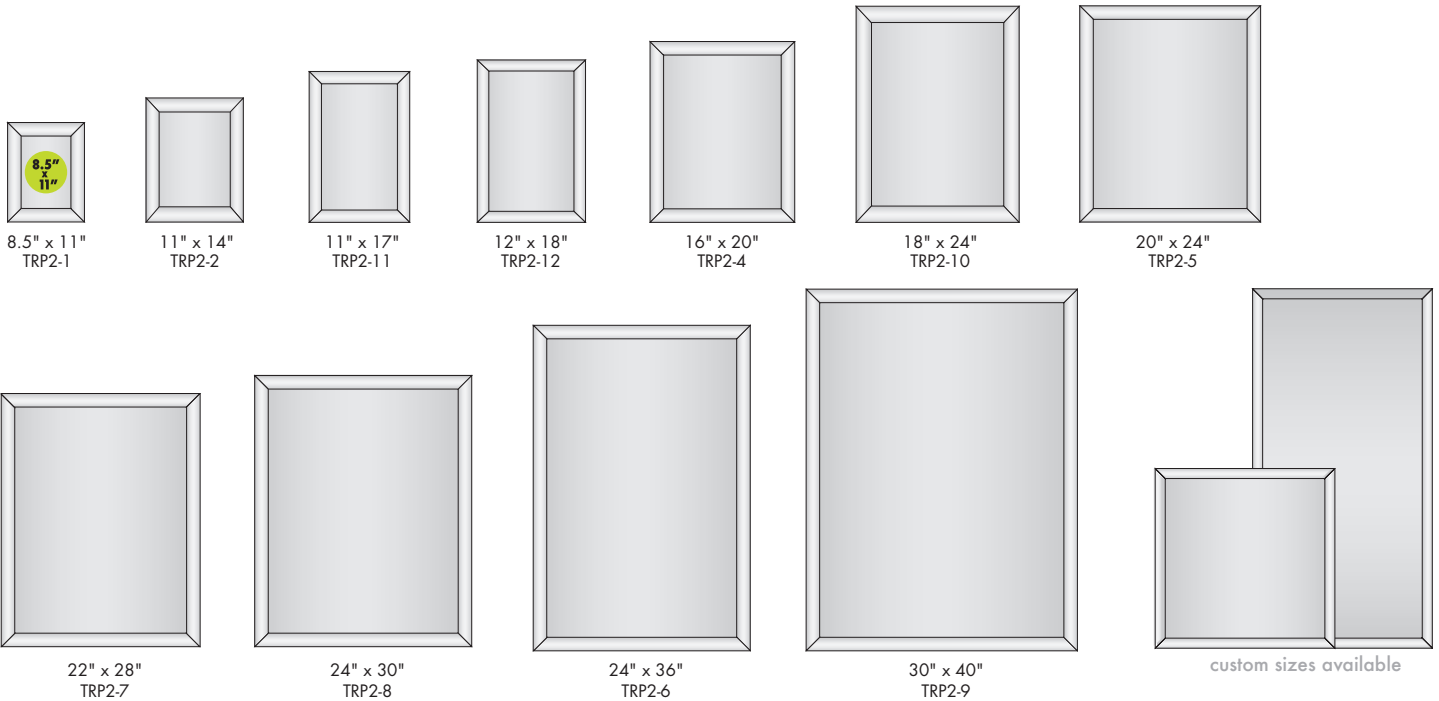

SNAP-EDGE

TRP CUSTOM

- \\ Trappa Poster Frame offers a simple, elegant snap rail solution for your custom-sized needs.
- \\ Combines two custom-length spring loaded snap rails with a backer
- \\ Comes with clear non-glare lens
- \\ Allows you to mount to a wall just by inserting the poster and snapping the edges shut
- \\ Rails, backer and lens are cut to size, depending on your graphic dimensions and desired rail length

SUGGESTED POPULAR SIZES

8.5" x 11"

11" x 17"

20" x 24"

22" x 28"

24" x 36"

24" x 48"

30" x 40"

36" x 52"



SNAP-LED

TRAPPA

- \\ 1" thick
- \\ 50,000 hr bulb life
- \\ Evenly distributed light
- \\ Snap frame allows easy graphic changes
- \\ Wall mounting hardware
- \\ Power supply with 78" cord
- \\ One year warranty

frame snaps open from the front



light box cord connects to wall adapter, illuminating the frame

CODE	SIZE
LED-SNAP-04	30"w x 40"h
LED-SNAP-05	36"w x 48"h



also available as hanging signs with our suspending clips



LED diffuser panel ensures even light distribution and brightness



POSTER SNAPPER

TRAPPA

- \\ Creates a clean, simple, elegant look
- \\ Hanging clips feature a top opening for clear nylon line mount as well as a recessed pocket for S-hook suspension
- \\ Adjustable hanging clips
- \\ Rails snap open and shut for quick graphic changes
- \\ Comes in four different standard widths: 24", 30", 36" and 48"
- \\ Custom-cut width available up to 60"

hanging options:

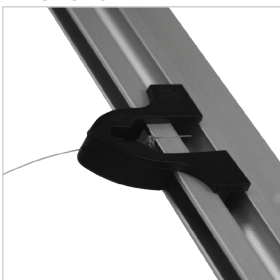

nylon line

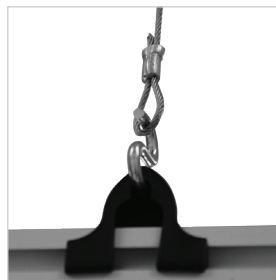

S-hook



snap graphic rail for easy change-out

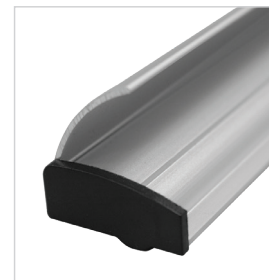

snap rail

PJ-SNAP

PROJECTING

- \\ Available in a wide range of sizes in black or silver
- \\ Double-sided projecting snap frames come with clear non-glare lenses
- \\ Fully assembled
- \\ Spring-loaded edges allows quick and easy graphic changes

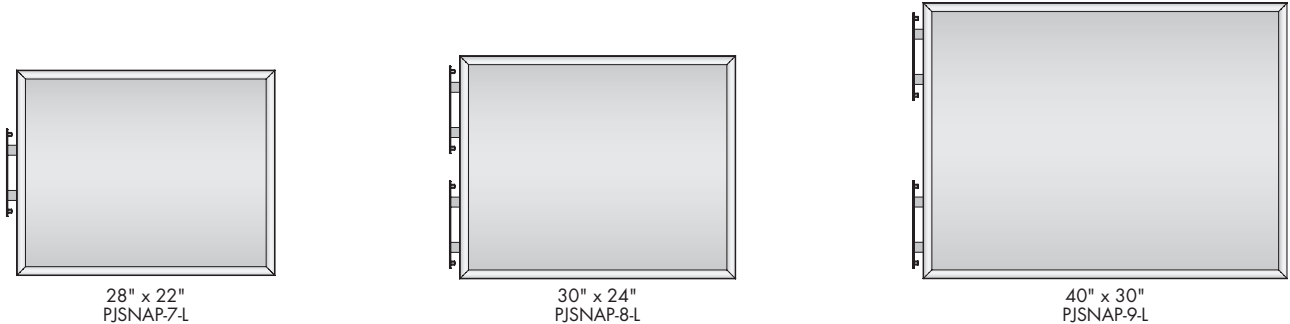
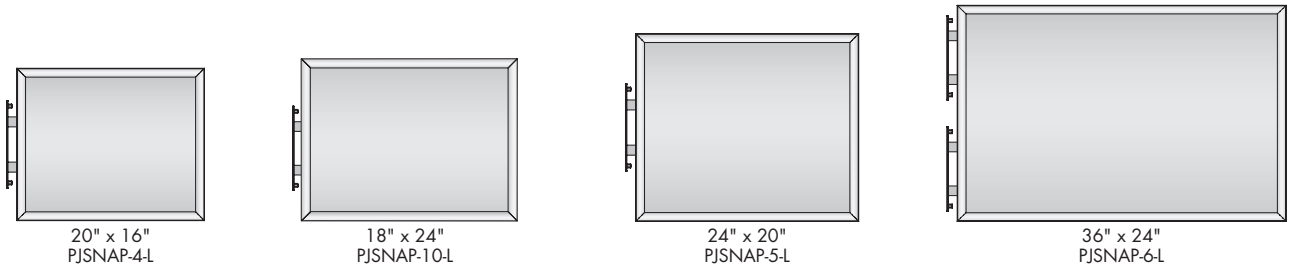
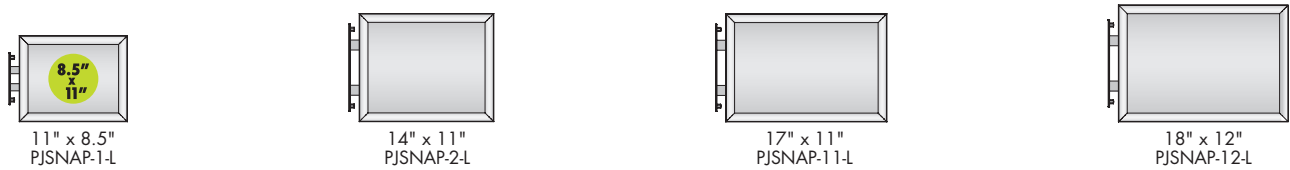
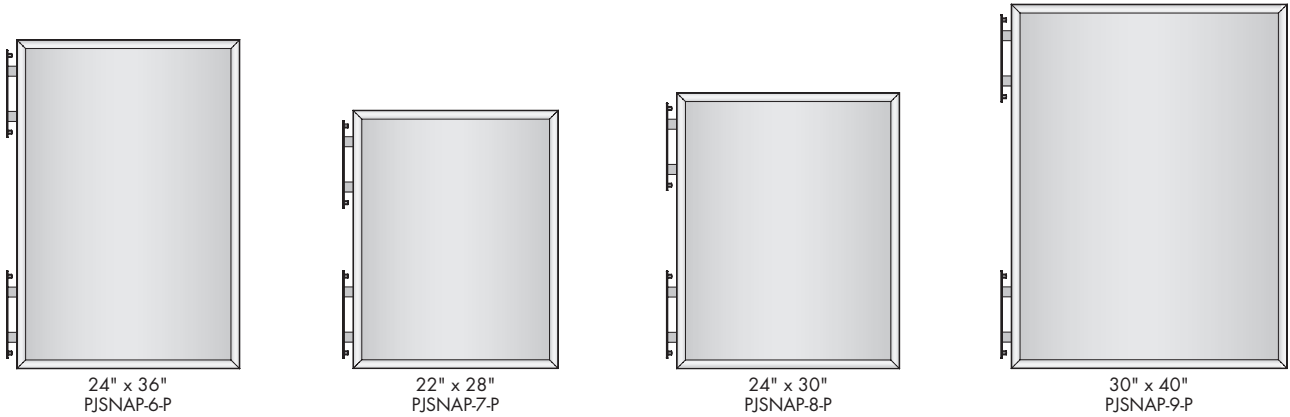
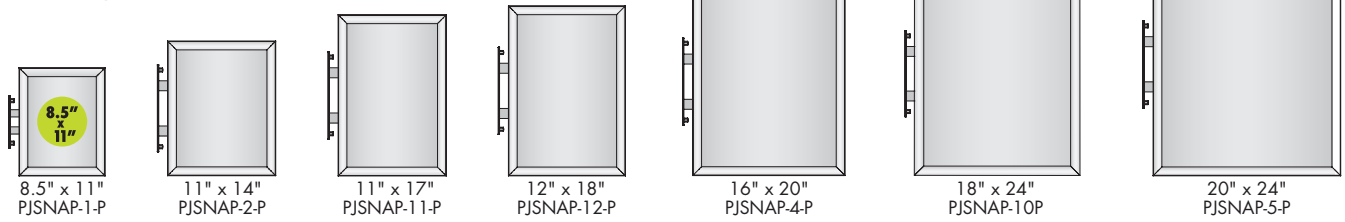
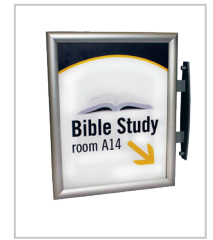

SUSP-SNAP

SUSPENDED



- \\ Available in a wide range of sizes in black or silver
- \\ Double-sided projecting snap frames come with clear non-glare lenses
- \\ Fully assembled

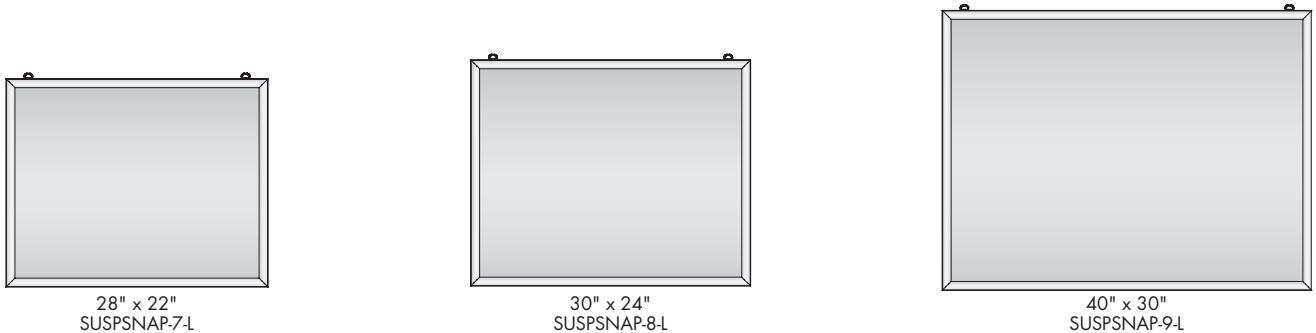
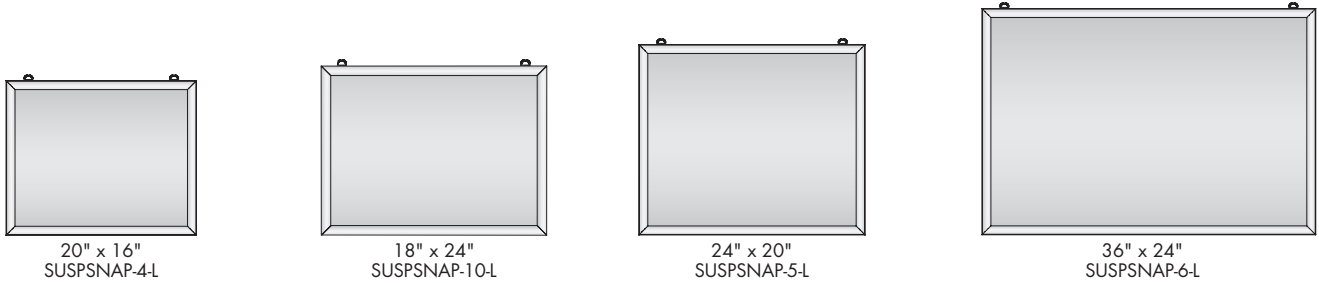
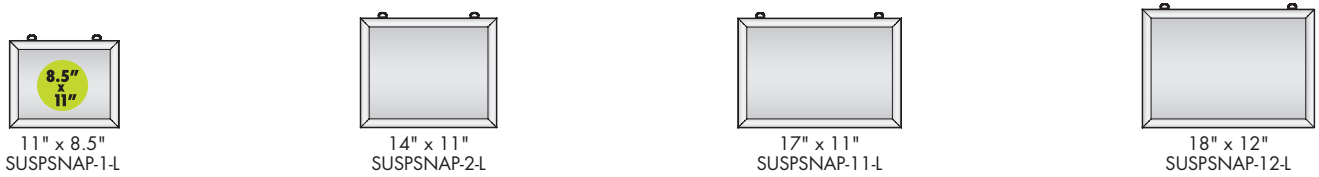
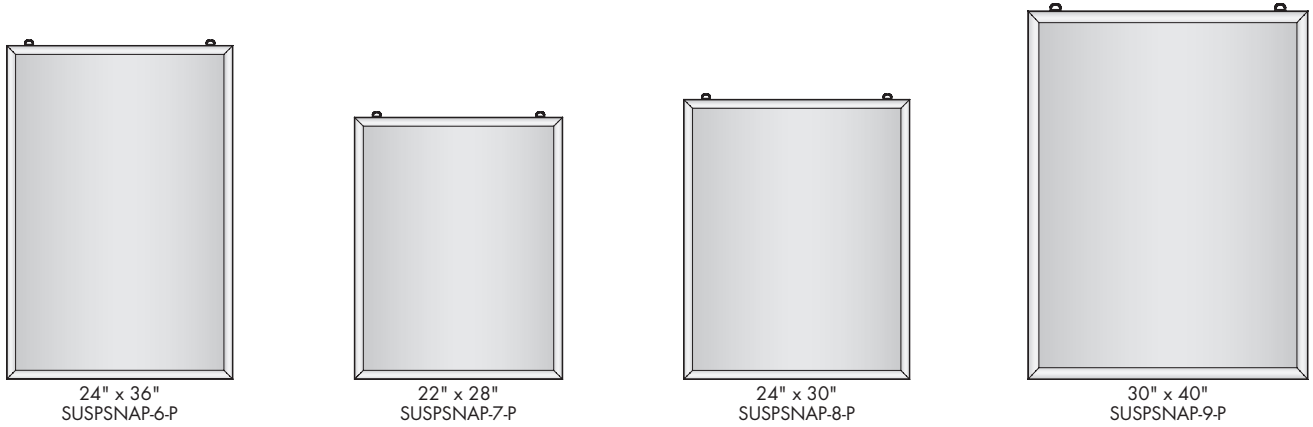
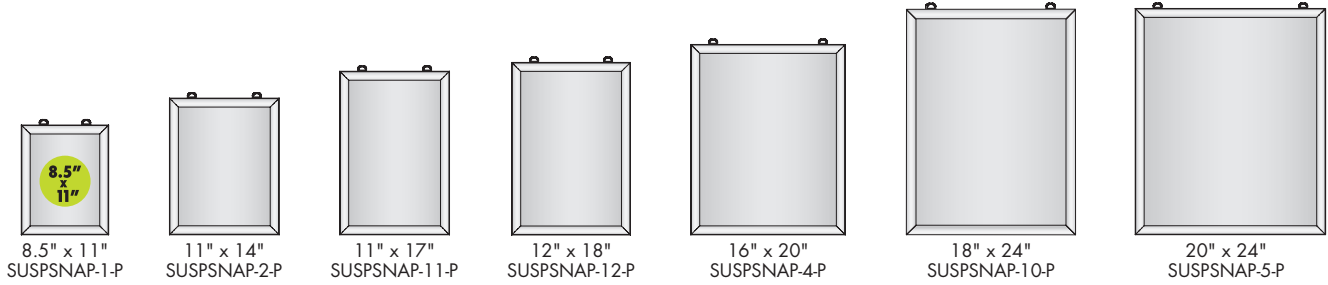

DISPLAYS

PYLONS

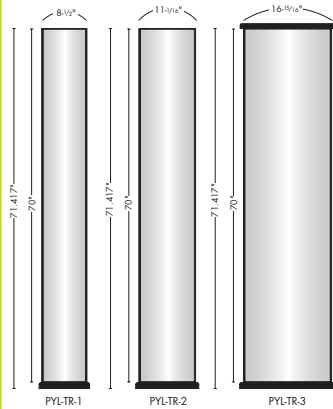
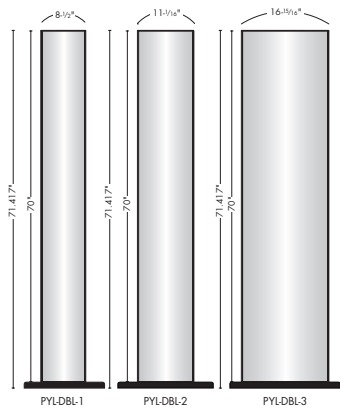

variable frame size options
add versatility

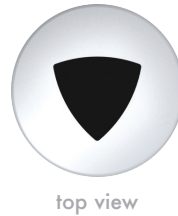
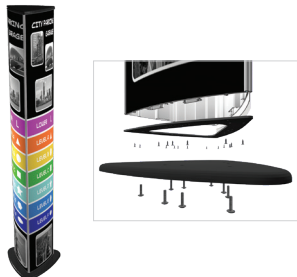
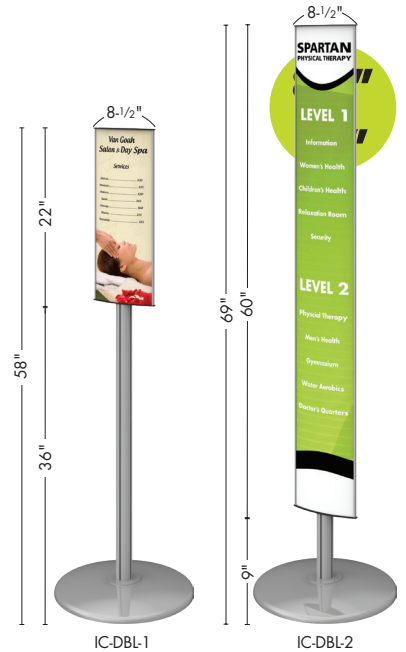

top view



top view

PYL-DBL Series

PYL-DBL

- \\ Double-sided standing pylon display
- \\ Choice of silver or black frames/extrusions
- \\ Black laminate bottom plate with steel support plates
- \\ Includes clear non-glare protective lenses
- \\ Requires assembly

PYL-TR Series

PYL-TR

- \\ Triangular shaped standing pylon display
- \\ Choice of silver or black frames/extrusions
- \\ Black laminate bottom plate with steel support plates
- \\ Black powder coated steel top plate for PYL-TR1 & 2/Thermoformed plate on PYL-TR3
- \\ Includes clear non-glare protective lenses
- \\ Requires assembly

IC-TR Series

IC-TR

- \\ Triangular shape
- \\ Silver or black curved high quality aluminum extrusions
- \\ Silver aluminum post, silver steel domed foot plate
- \\ Black powder-coated steel top and bottom plate
- \\ Clear non-glare protective lenses can be removed for a quick graphic change
- \\ Custom heights available
- \\ Requires assembly

IC-DBL Series

IC-DBL

- \\ Silver or black curved high quality aluminum extrusions
- \\ Silver aluminum post, silver steel domed foot plate
- \\ Black powder-coated steel bottom plate, black molded plastic top plate
- \\ Clear non-glare protective lenses can be removed for a quick graphic change
- \\ Double sided
- \\ Custom heights available
- \\ Requires assembly